

Panasonic®

Operating Instructions

CO₂ Incubator

MCO-170AIC

MCO-170AICUV

MCO-170AICUVH

MCO-170AIC

MCO-170AICUV

MCO-170AICUVH Series



Please read the operating instructions carefully before using this product, and save the operating instructions for future use.

See page 91 for all model numbers.

CONTENTS

INTRODUCTION	P. 3
INTENDED USE AND PRECAUTIONS	P. 3
PRECAUTIONS FOR SAFE OPERATION	P. 4
LABELS ON INCUBATOR	P. 8
SYMBOLS ON INCUBATOR	P. 9
ENVIRONMENTAL CONDITIONS	P. 9
INCUBATOR COMPONENTS	
Unit	P. 10
LCD touch panel	P. 12
Remote alarm terminal	P. 15
INSTALLATION	
Installation site	P. 16
Installation	P. 18
Connecting CO ₂ gas cylinder	P. 20
BEFORE COMMENCING OPERATION	
Initial cleaning method	P. 21
Removing inner attachments	P. 22
Installing inner attachments	P. 24
Filling humidifying pan	P. 25
FOR BETTER CULTIVATION	
Precautions for cultures	P. 26
Preventing contamination	P. 27
CORRECT OPERATION	P. 28
BASIC OPERATION ON LCD TOUCH PANEL	P. 29
BASIC PARAMETERS	
Numerical input to input window	P. 31
Setting temperature, CO ₂ density and high limit temperature alarm	P. 32
Setting key lock	P. 34
Removing key lock	P. 36
ALARM PARAMETERS	P. 37
OPERATION/ALARM LOG	
Setting log interval	P. 40
Displaying operation log	P. 41
Exporting operation log	P. 44
Displaying alarm log	P. 47
Exporting alarm log	P. 49
OTHER PARAMETERS	
Setting date and time	P. 52
Setting brightness and sleep	P. 54
Setting DAQ	P. 55

CONTENTS

UV LAMP PARAMETERS	P. 56
Using UV lamp	P. 56
Setting UV lamp ON period	P. 57
Lighting UV lamp for 24 hours	P. 59
H ₂ O ₂ DECONTAMINATION	P. 61
H ₂ O ₂ decontamination	P. 62
Precautions when handling H ₂ O ₂ reagent	P. 66
Using unlock key	P. 66
ELECTRIC LOCK (OPTION)	P. 67
Setting auto lock	P. 67
Using unlock key	P. 68
Removing auto lock	P. 69
GAS AUTO CHANGER (OPTION)	P. 70
Connecting CO ₂ gas cylinder	P. 70
Automatic CO ₂ gas supply line changeover	P. 71
Manual CO ₂ gas supply line changeover	P. 73
STD GAS AUTO CALIBRATION KIT (OPTION)	P. 74
ROUTINE MAINTENANCE	P. 77
ALARMS, SAFETY, AND SELF-DIAGNOSIS	P. 78
TROUBLESHOOTING	P. 81
DISPOSAL OF UNIT	P. 84
SPECIFICATIONS	P. 89
PERFORMANCE	P. 91
SAFETY CHECK SHEET	P. 92

INTRODUCTION

- Read the operating instructions carefully before using the Product and follow the instructions for safety operation.
- Our company disavows any responsibility for safety if the Product is used for other than the intended use or used with any procedures other than those given in the operating instructions.
- Keep the operating instructions in a suitable place so that it can be referred to as necessary.
- The contents of the operating instructions are subject to change without notice for improvement of performance or functions.
- Contact our sales representative or agent if any page of the operating instructions is lost or the page order is incorrect.
- Contact our sales representative or agent if any point in the operating instructions is unclear or if there are any inaccuracies.
- No part of the operating instructions may be reproduced in any form without the expressed written permission of our company.

CAUTION

Our company guarantees the product under certain warranty conditions. Our company in no way shall be responsible for any loss of content or damage of content.

INTENDED USE AND PRECAUTIONS

This equipment is designed for culture of cell tissues, organs, embryos.

- The adapted culture condition depends on the sample kind. It is necessary to determine the culture temperature, CO₂ density and culture period suitable for the purpose.
- For the embryos, the low O₂ density should be better for culture. It is recommended to use O₂/CO₂ Incubator.
- For IVF/ART purpose, special attention should be paid to traceability since incidents might be disclosed several months or years later, at the baby's birth or even later during its life. Therefore we recommend to maintain the following data; product serial number, incubation term and incubation parameters.
(Refer to details on MEDDEV 2.2/4)

PRECAUTIONS FOR SAFE OPERATION

It is imperative that the user complies with the operating instructions as it contains important safety advice.

Items and procedures are described so that you can use this unit correctly and safely. If the precautions advised are followed, this will prevent possible injury to the user and any other person.

Precautions are illustrated in the following way:



WARNING

Failure to observe WARNING signs could result in a hazard to personnel possibly resulting in serious injury or death.

CAUTION

Failure to observe CAUTION signs could result in injury to personnel and damage to the unit and associated property.

Symbol shows;

-  this symbol means caution.
-  this symbol means an action is prohibited.
-  this symbol means an instruction must be followed.

Be sure to keep the operating instructions in a place accessible to users of this unit.

< Label on the unit >











This mark is labeled on the cover in which the electrical components of high voltage are enclosed to prevent the electric shock.

The cover should be removed by a qualified engineer or a service personnel only.

WARNING

















As with any equipment that uses CO₂ gas, there is a likelihood of oxygen depletion in the vicinity of the equipment. It is important that you assess the work site to ensure there is suitable and sufficient ventilation. If restricted ventilation is suspected, then other methods of ensuring a safe environment must be considered. These may include atmosphere monitoring and warning devices.

WARNING











-  **Do not use the unit outdoors.** Current leakage or electric shock may result if the unit is exposed to rain water.
-  **Only qualified engineers or service personnel should install the unit.** The installation by unqualified personnel may cause electric shock or fire.
-  **Install the unit on a sturdy floor and take an adequate precaution to prevent the unit from turning over.** If the floor is not strong enough or the installation site is not adequate, this may result in injury from the unit falling or tipping over.
-  **Never install the unit in a humid place or a place where it is likely to be splashed by water.** Deterioration of the insulation may result which could cause current leakage or electric shock.
-  **Never install the unit in a flammable or volatile location.** This may cause explosion or fire.
-  **Never install the unit where acid or corrosive gases are present** as current leakage or electric shock may result due to corrosion.
-  **Always ground (earth) the unit to prevent electric shock.** If the power supply outlet is not grounded, it will be necessary to install a ground by qualified engineers.
-  **Never ground the unit through a gas pipe, water main, telephone line or lightning rod.** Such grounding may cause electric shock in the case of an incomplete circuit.
-  **Connect the unit to a power source as indicated on the rating label attached to the unit.** Use of any other voltage or frequency other than that on the rating label may cause fire or electric shock.
-  **Never store volatile or flammable substances** in this unit if the container cannot be sealed. These may cause explosion or fire.
-  **Do not insert metal objects such as a pin or a wire into any vent, gap or any outlet on the unit.** This may cause electric shock or injury by accidental contact with moving parts.
-  **Use this unit in safe area when treating the poison, harmful or radiate articles.** Improper use may cause bad effect on your health or environment.
-  **Turn off the power switch (if provided) and disconnect the power supply to the unit prior to any repair or maintenance** of the unit in order to prevent electric shock or injury.
-  **Do not touch any electrical parts (such as power supply plug) or operate switches with a wet hand.** This may cause electric shock.

PRECAUTIONS FOR SAFE OPERATION

WARNING

-  **Ensure you do not inhale or consume medication or aerosols** from around the unit at the time of maintenance. These may be harmful to your health.
-  **Never splash water directly onto the unit** as this may cause electric shock or short circuit.
-  **Never put containers with liquid on the unit** as this may cause electric shock or short circuit when the liquid is spilled.
-  **Never bind, process, or step on the power supply cord, or never damage or break the power supply plug.** A broken supply cord or plug may cause fire or electric shock.
-  **Do not use the supply cord if its plug is loose.** Such supply cord may cause fire or electric shock.
-  **Never disassemble, repair, or modify the unit yourself.** Any such work carried out by an unauthorized person may result in fire, or electric shock or injury due to a malfunction.
-  **Disconnect the power supply plug if there is something wrong with the unit.** Continued abnormal operation may cause electric shock or fire.
-  **When removing the plug from the power supply outlet, grip the power supply plug,** not the cord. Pulling the cord may result in electric shock or fire by short circuit.
-  **Disconnect the power supply plug** before moving the unit. Take care not to damage the power cord. A damaged cord may cause electric shock or fire.
-  **Disconnect the power plug when the unit is not used for long periods.** Keeping the connection may cause electric shock, current leakage, or fire due to the deterioration of insulation.
-  If the unit is to be stored unused in an unsupervised area for an extended period, **ensure that children do not have access and that doors cannot be closed completely.**
-  **The disposal of the unit should be accomplished by appropriate personnel.** Remove doors to prevent accidents such as suffocation.
-  **Do not put the packing plastic bag within reach of children** as suffocation may result.
-  **Use the reagent specified by our company for H₂O₂ decontamination.** Using a different H₂O₂ solution may result in explosion or damage to the incubator.
-  When performing H₂O₂ decontamination, **securely close the internal and external doors.** Failure to do so may be harmful to health due to leakage of H₂O₂ gas.
-  During H₂O₂ decontamination, **plug the access hole with the silicon cap that is provided.** Failure to do so may be harmful to health due to leakage of H₂O₂ gas.
-  **Always use the removal power supply cord that is provided.** Other power supply cord may cause electric shock or fire.





CAUTION

-  This unit must be plugged into a dedicated circuit protected by branch circuit breaker.
-  Use a dedicated power source as indicated on the rating label attached to the unit. A multiple-tap may cause fire resulting from abnormal heating.
-  **Never store corrosive substances such as acid or alkali** in this unit if the container cannot be sealed. These may cause corrosion of inner components or electric parts.
-  **Check the setting when starting up of operation after power failure or turning off of power switch.** The stored items may be damaged due to the change of setting.
-  **Be careful not to tip over the unit** during movement to prevent damage or injury.
-  **Prepare a safety check sheet** (copy the last page) when you request any repair or maintenance for the safety of service personnel.
-  **Wear rubber gloves when handling the H₂O₂ reagent.** Direct contact with the H₂O₂ reagent may result in inflammation of the skin.
-  H₂O₂ decontamination can be performed only for the chamber and chamber attachments with standard specifications, and not for any other objects.
-  **Perform H₂O₂ decontamination with the chamber attachments arranged as specified by our company.** Arranging them in a different way may result in insufficient decontamination.
-  After H₂O₂ decontamination has been completed, **wear rubber gloves and use a non-woven cloth to wipe off the residual H₂O₂ fluid from the bottom of the chamber, any objects that were decontaminated, and the bottoms of ducts.**

LABELS ON INCUBATOR



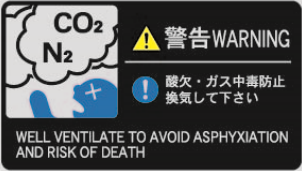

Warning Safety Labels Applied to the Incubator

Users are advised to avoid accidents by carefully reading the warnings and cautions contained on warning stickers at key locations on the interior and exterior of the incubator.

Possible Danger	Warning/Caution Type Location of Danger	Warning/Caution Label	Description of Danger
Burns	Hot Surface Cooling Unit & Heat Cover		Avoid touching the cooling unit and heat cover, which reaches high temperatures and may cause burns.
Personal injury	Hazardous UV Light Interior		The UV lamp lights by pressing the door switch. Do not press the door switch because the UV light is hazardous.
Personal injury	Hazardous UV Light Interior		The UV light is hazardous. Never turn on the UV lamp without the cover.
Personal injury	Gas Poisoning or Oxygen Deprivation Environment		When using CO ₂ gas for control, make sure that there is adequate ventilation. Using CO ₂ gas in a small room without adequate ventilation may cause gas poisoning or oxygen deprivation. In addition, when opening the Incubator doors, do not directly inhale the air in the chamber.
Personal injury	Gas Poisoning or Oxygen Deprivation Interior		Excessive pressure may cause gas supply lines inside the Incubator to come loose, which may result in gas poisoning or oxygen deprivation due to the escaping of gas.

SYMBOLS ON INCUBATOR

The symbols are attached to the incubator. The following table describes the symbols.

	This symbol is attached to covers that access high-voltage electrical components to prevent electric shock. Only a qualified engineer or service personnel should be allowed to open these covers.
	This symbol indicates an ultraviolet light (UV) caution.
	This symbol indicates that caution is required. Refer to product documentation for details.
	This symbol indicates a hot surface.
	This symbol indicates an earth.
	This symbol means "ON" for a power switch.
○	This symbol means "OFF" for a power switch.

ENVIRONMENTAL CONDITIONS

This equipment is designed to be safe at least under the following conditions (based on the IEC-61010-1):

- Indoor use;
- Altitude up to 2000 m;
- Temperature 5°C to 40°C
- Maximum relative humidity 80% for temperature up to 31°C decreasing linearly to 50% relative humidity at 40°C;
- Mains supply voltage fluctuations up to $\pm 10\%$ of the nominal voltage;
- Transient overvoltages up to the levels of OVERVOLTAGE CATEGORY II;
- Temporary OVERVOLTAGES occurring on the mains supply;
- Applicable pollution degree of the intended environment (POLLUTION DEGREE 2 in most cases);

INCUBATOR COMPONENTS

Unit

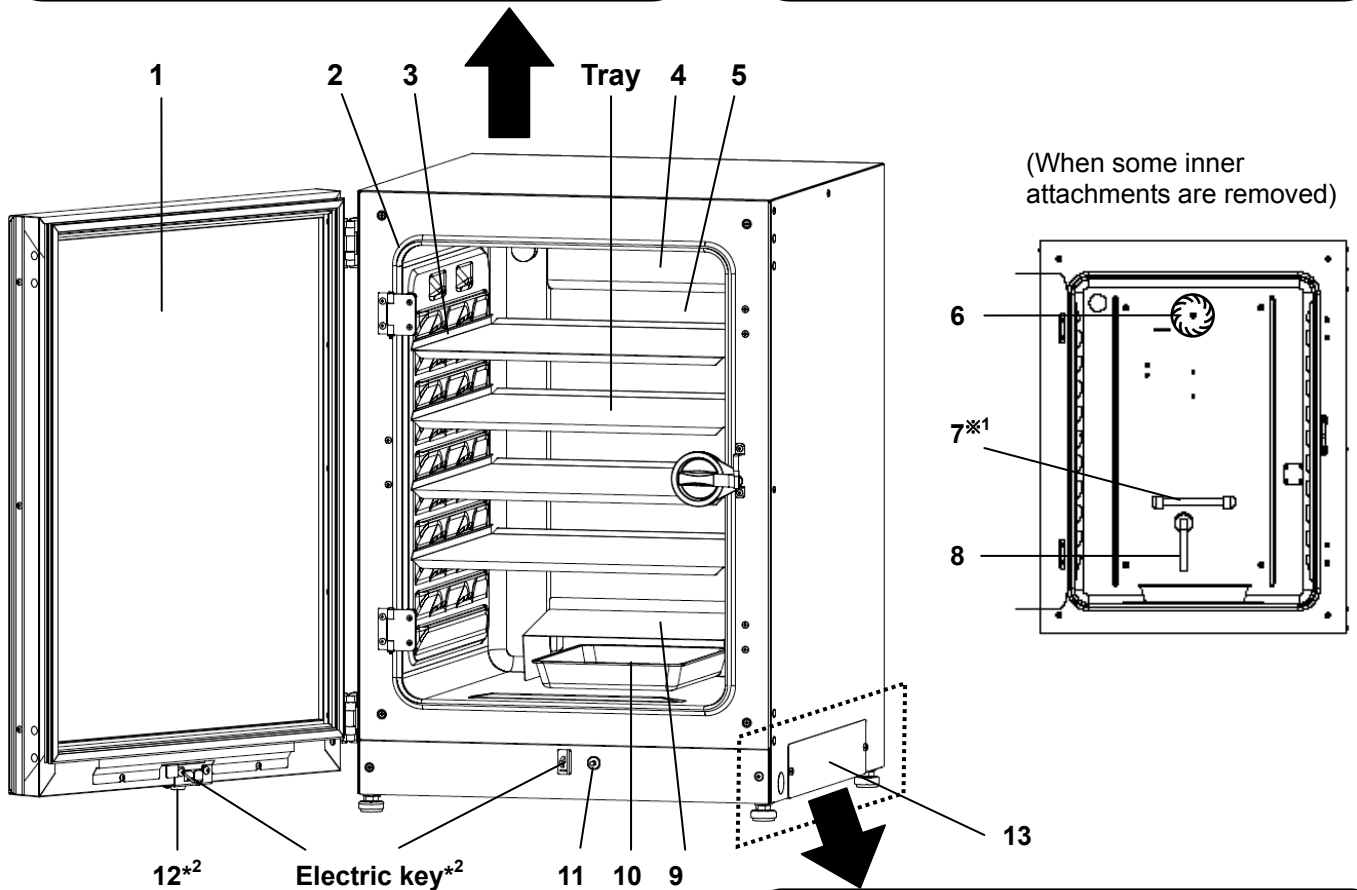
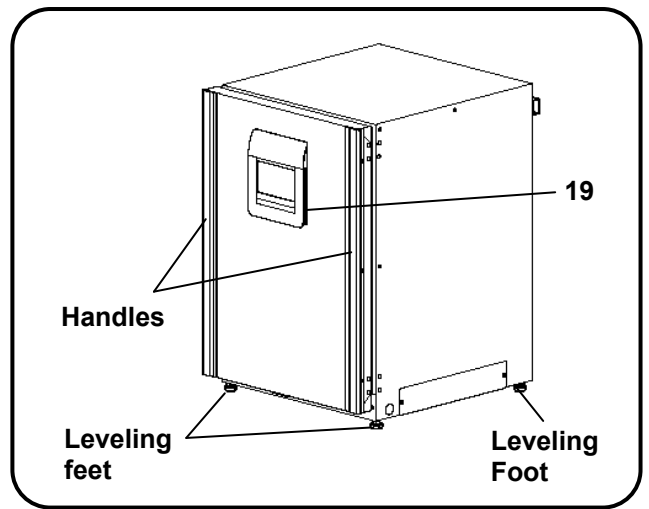
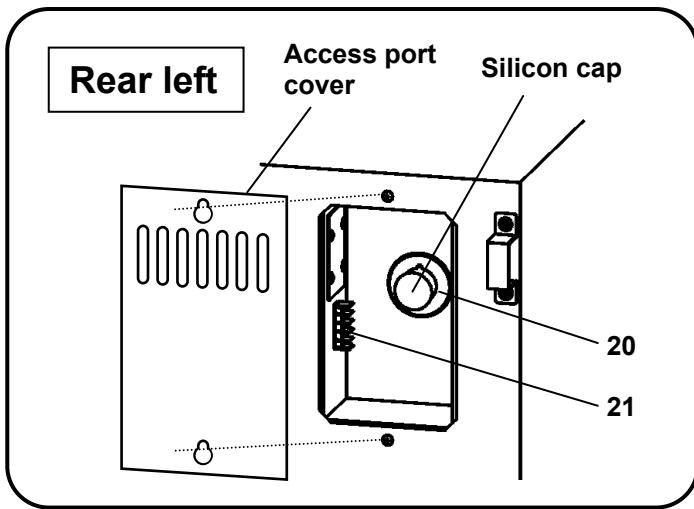

(When some inner attachments are removed)

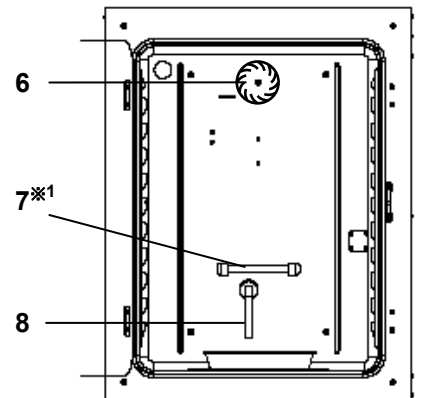

*1: MCO-170AICUVH/170AICUV or when an optional UV system set MCO-170UVS is installed.

*2: MCO-170AICUVH or when an optional electric lock MCO-170EL is installed.

Lower right side (When 13 is removed)

Sample air outlet cap Removal power supply cord port

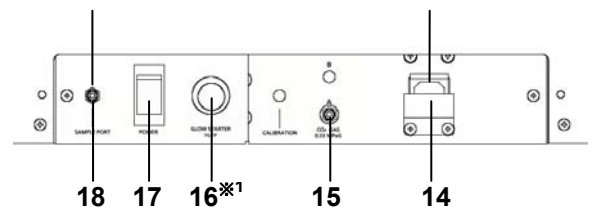

1. Outer door: The outer door is held to the frame with the magnetic seal. The door heater is installed in the door panel. The door opening is reversible. Contact our sales representative or agent to change the door hinge from left to right or vice versa.

2. Inner door: The inner door is made of tempered glass. However do not subject the glass to excessive impacts.

3. Tray catches: Insert tray to fit the concave portion on chamber.

4. Fan cover: The fan cover serves as the inlet for circulating air. It is removable.

5. Duct: The duct for the path for circulating air. It is removable.

6. Fan (inside the duct): The fan is made from polypropylene resin. It can be disinfected in an autoclave.

7. UV lamp*¹: This UV lamp does not generate ozone. Never look directly at the UV light. For replacement, contact our sales representative or agent.

8. Humidity control bar: Reduce automatically dew condensation occurred by the effect of outside environment and the frequency of door opening/closing.

The humidity control bar has bactericidal effects by plated surface of it. However, it is recommended to replace the humidity control bar every 5 to 6 years to maintain bactericidal effects. (The duration of bactericidal effects differs depending on the use environment.)

9. Humidifying pan cover: This cover prevents the UV light entering the chamber. Always use it. Using without it may have a bad influence on the chamber temperature distribution and humidity recovery.

10. Humidifying pan: Fill the humidifying pan with sterile distilled water. Install the humidifying pan in a longitudinal direction as its shorter side is placed in the back.

11. Door switch: Detects the door opening/closing and stops the fan and electromagnetic valve for CO₂ when the door is open. The UV lamp*¹ is also deactivated by the door opening.

12. Key hole*²: This is the hole to unlock with unlock key while outer door is locked by electric lock.

13. Switch cover: Prevent the accident of gas tube disconnected by the unexpected touch or power off.

14. Power supply cord cover plate: This plate is to prevent the power cord being come off.

15. Connecting port A for CO₂ gas pipe: Refer to page 20 for gas cylinder connection. Ensure that the gas pressure is set at 0.03 MPa(G) (0.3 kgf/cm²(G), 4.3 psi(G)).

Note: When the optional MCO-21GC gas auto changer is installed, both ports A and B are available. Refer to page 70 for gas auto changer.

16. Glow starter*¹: The glow is started for the UV lamp. (Type FG-7P or FG-7PL)

17. Power switch: This is the main switch for the incubator. It also functions as an overcurrent breaker.

18. Sample air outlet: The sample air outlet also functions as an internal gas outlet. Normally, cover this outlet with the sample air outlet cap.

19. USB port: Insert USB memory to export operations and alarms log. Refer to page 40~51.

Note: It is impossible to use USB memory which is required password input.

20. Access port: Place the silicon caps on both outside and inside of the port when the port is not being used.

21. Remote alarm terminals: This terminal informs the alarm to remote location by connecting to external alarm unit. Refer to page 15.

INCUBATOR COMPONENTS

LCD touch panel

The following display (called the Top screen) will appear when the power switch is turned ON.

Note: It takes approximately 20 seconds until Top screen is displayed.

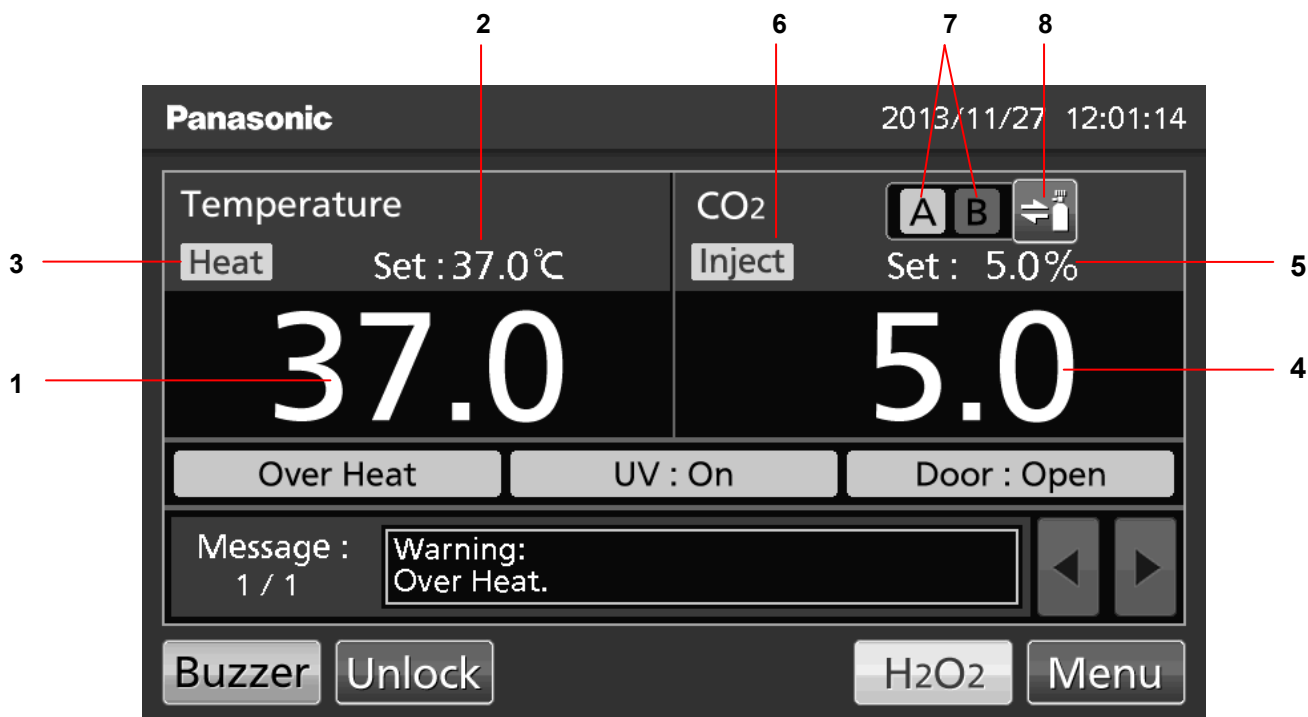

1. Present temperature display field

The current chamber temperature is displayed.

2. Set temperature value display field

The set value of chamber temperature is displayed. Default setting: 37 °C

3. Heating indicator

This lamp lights when the heater is energized.

4. Present CO₂ density display field

The current chamber CO₂ density is displayed. Nothing is displayed when CO₂ density is set 0%.

5. Set CO₂ density value display field

The set value of the chamber CO₂ density is displayed. Default setting: 0 %

6. CO₂ gas injection indicator

This lamp lights when CO₂ gas is being injected.

7. CO₂ gas supply line indicator A and B*¹

Current supplying CO₂ gas supply line (connecting port for CO₂ gas pipe) is displayed. The connecting port A/B for gas pipe that is currently supplying CO₂ is displayed in reverse video and blinks.

8. CO₂ gas supply line select key*¹

This is a key to select CO₂ gas supply line A or B (Connecting port A or B for CO₂ gas pipe). When an optional gas auto charger MCO-21GC is installed, CO₂ gas supply line A/B changes over automatically when CO₂ gas cylinder is empty. Changeover is also workable by pressing this key.

*1: Only when an optional component MCO-21GC (Gas auto charger) is installed, this key is workable. They are not displayed when the MCO-21GC is not installed.

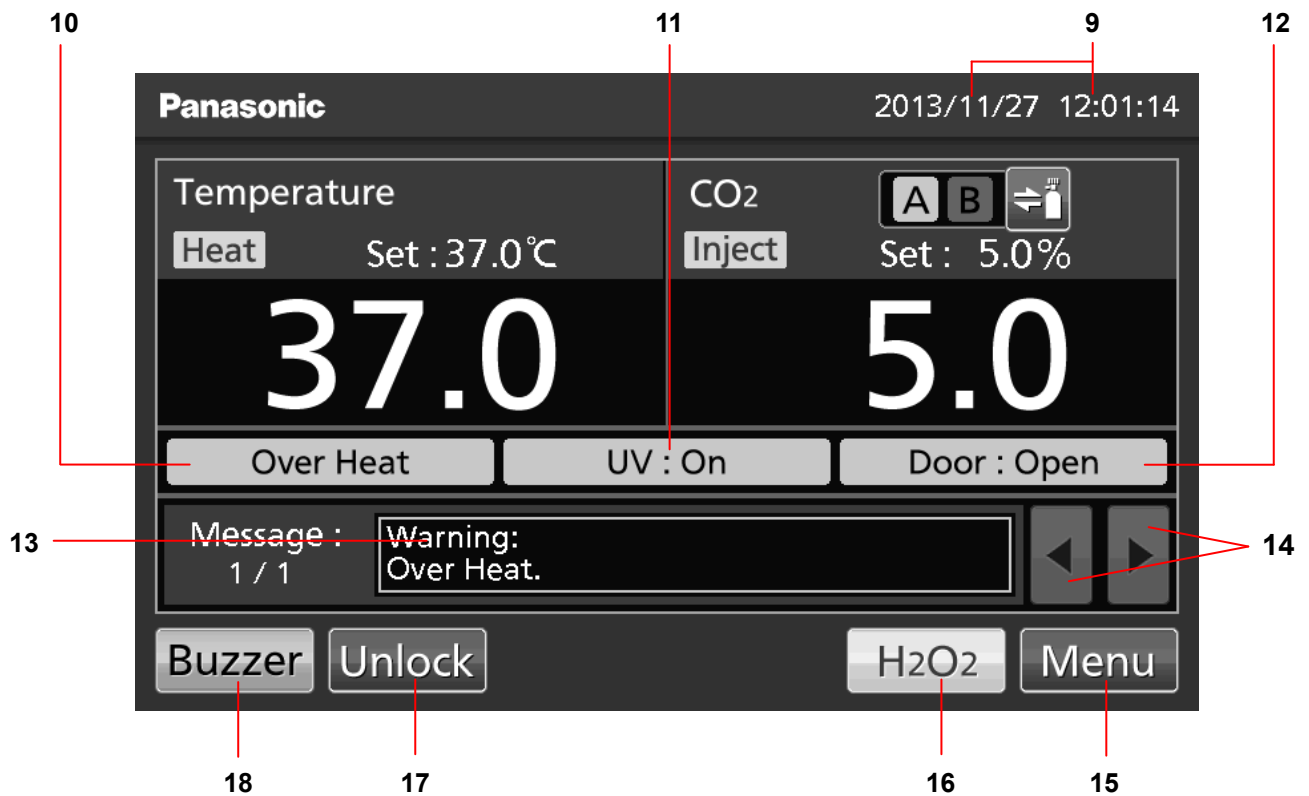

9. Present date/time display field

Normally, this indicator shows date and time. The date and time is simply set when the incubator is shipped from the factory. Refer to page 52 for details.

10. Over heat display

High limit temperature alarm is activated: "Over Heat" is displayed alternately in normal characters and reverse video.

11. UV lamp condition display

UV lamp ON: "UV : On" is displayed.
 UV lamp OFF: "UV : Off" is displayed.
Note: Nothing is displayed when an optional UV system set MCO-170UVS is not installed to the MCO-170AIC.

12. Outer door (opening/closing) display

Open: "Door : Open" is displayed alternately in normal characters and reverse video.
 Close: "Door : Closed" is displayed.
 Locked: "Door : Locked" is displayed.*2

13. Message display field

Alarms, errors or messages are displayed when fault occurs. Refer to page 78~80.
Note: When there are a number of alarms/errors, the display shows the message. For example, if 2 alarms/errors occur in total, the display shows "1/2".

14. Message select key

When there are a number of alarm/errors, the message on the screen is changeable.

15. Menu key

Press this key to lead the Menu screen. It is possible to set various setting on the Menu screen. Refer to page 29.

*2: Auto lock function by electric lock is workable under any of the following conditions. When the condition is not fulfilled, "Door : Locked" or Unlock key are not displayed.

•MCO-170AICUVH. •When an optional electric lock MCO-170EL is installed.

INCUBATOR COMPONENTS

16. H₂O₂ key*³

This key is to run H₂O₂ decontamination. Refer to page 61 to 66.

17. Unlock key*²

Press this key is to unlock the outer door when it is auto-locked by electric lock. Refer to page 67 to 69. When the auto lock function is OFF, this key is not displayed.

18. Buzzer key

Press this key to silence the buzzer. However, when the ring back is ON, the buzzer will sound again when the ring back passed and the alarm state still continues. Refer to page 38~39 and 78~80.

Note: It is not possible to silence the buzzer for the high limit temperature alarm.

*3: The H₂O₂ decontamination function is workable under any of the following conditions. When the condition is not fulfilled, the H₂O₂ key is not displayed on the LCD touch panel.

•When an H₂O₂ generator MCO-HP is installed in the MCO-170AICUVH.

•When all H₂O₂ generator MCO-HP, H₂O₂ decon board MCO-170HB and electric lock MCO-170EL are installed in the MCO-170AICUV.

•When all UV system set MCO-170UVS, H₂O₂ generator MCO-HP, H₂O₂ decon board MCO-170HB and electric lock MCO-170EL are installed in the MCO-170AIC.

Remote alarm terminal

The alarm of this product can be informed at a remote location from this product by connecting the external alarm unit to the remote alarm terminals. For the type and behavior of remote alarm output, refer to page 78 to 80.

The terminal of the remote alarm is installed at the rear upper right of the unit (See the figure on the point). The alarm is outputted from this terminal. Contact capacity is DC 30 V, 2 A.

When Buzzer key is pressed, the behavior of the remote alarm is showed in Table.1.

Note:

- In the door alarm, the remote alarm does not work. Refer to page 78 to 79.
- For wiring of a remote alarm, contact qualified service personnel.

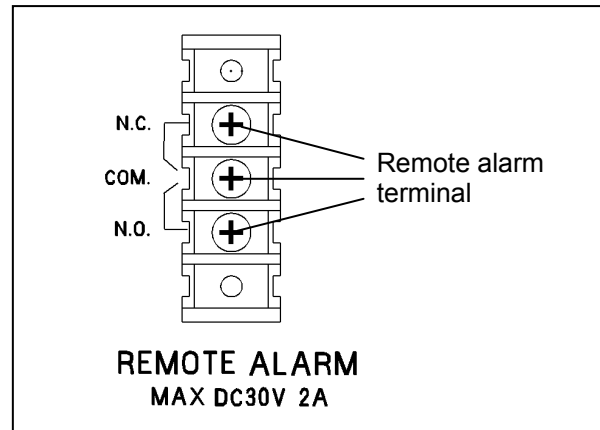

Table 1 The behavior of the remote alarm when pressing the Buzzer key

Remote Alarm setting (Refer to page 37~39)	Connecting terminal	Normal condition	Abnormal condition (Including in the cases of power outage and of where the power plug is pulled out.)	
			When pressing the buzzer key	
ON:	COM.-N.C.	Close	Open	Open (Maintain in abnormality)*
Non-interlock with Buzzer key	COM.-N.O.	Open	Close	Close (Maintain in abnormality)*
OFF:	COM.-N.C.	Close	Open	Close (Return to normal)
Interlock with Buzzer key	COM.-N.O.	Open	Close	Open (Return to normal)

*In case of Err01 (CO₂ gas cylinder empty), Err11, 12(CO₂ sensor error), the condition returns to normal.

Use a twisted sealed wire for the connection.
 Type: UL 2343, UL 2448, UL 2464, UL 2552, UL2623.
 Length:30 m max.

INSTALLATION

Installation site

For correct operation of the incubator, install it in a location with the following conditions.

WARNING

When using CO₂ gas for control, **make sure that there is an adequate ventilation**. Using CO₂ gas in a small room without adequate ventilation may cause gas poisoning or oxygen deprivation. In addition, when opening the incubator doors, do not directly inhale the air in the chamber.

Si l'appareil est utilisé dans un endroit restreint, le niveau de la densité CO₂ de l'air peut s'élever et peut être nocif aux humains. Évitez d'aspirer l'air provenant de l'intérieur de l'appareil quand vous ouvrez la porte.

● **Normal air environment**

Install the incubator in an environment with normal air.

● **Do not expose to direct sunlight**

Do not install the incubator in a location where it will be exposed to direct sunlight. If the incubator is operated in direct sunlight, performance will be adversely affected.

● **Separate from heat sources**

Do not install the incubator near significant heat sources, such as heaters, boilers, ovens, or autoclaves. Heat will adversely affect the performance of the incubator.

● **Ambient temperature at least 5 °C lower than set temperature**

The control temperature of the incubator is at least 5 °C higher than the ambient temperature. For example, if the chamber is controlled at 37 °C, the ambient temperature must be 32 °C or less. Do not allow the ambient temperature to become too high.

● **Strong and level floor**

Select a site with a strong and level floor. If the floor is uneven or the installation is not level, the incubator will be unstable and this may cause accident or injury. To avoid vibration and noise, always make sure that the installation is stable. An unstable surface may result in vibration or noise.

WARNING

Install the incubator at a location that can support the weight. If the floor is not strong enough or if the installation is insufficient, the incubator may fall over and cause injury.

Always make sure that the floor is strong, even, and level, and that the incubator will not tip over. An insufficient installation may result in injury due to water leakage or the incubator falling over.

● **Low humidity**

Select a site with a relative humidity of 80 %R.H. or lower. Using the incubator in high humidity may result in current leakage or electric shock.

WARNING

Do not use the incubator outdoors. If the incubator is exposed to rain water, it may result in current leakage or electric shock.

Never install the incubator in a moist location, such as near a sink or water line, or where it is likely to be exposed to water. In addition, **do not install it near water or steam pipes.** Moisture can cause the insulation to deteriorate, which may result in current leakage or electric shock.

- **No inflammable or corrosive gas**

Never install the incubator in a location where it will be exposed to inflammable or corrosive gas. Doing so may result in explosion or fire. In addition, insulation may deteriorate due to corrosion of protective casing, resulting in current leakage or electric shock.

- **No falling objects**

Do not install the incubator in a location where there is the possibility of objects falling from above. Doing so may result in damage or accident.

INSTALLATION

Installation

1. Remove the packing tape and clean up.

Remove all the tapes that are securing the doors and the inner attachments. Open the doors for ventilation. If the outer panels are dirty, wet a cloth with a diluted neutral detergent and wipe them. (Undiluted detergent can damage the plastic components. For the dilution, refer to the instruction of the detergent.) Wipe off the residual detergent with a wet cloth and then wipe off any moisture.

Note: Remove the cable tie banding the power supply cord. Prolonged banding may cause the corrosion of the cord coating.

⚠ WARNING

Do not leave the plastic wrapping bags within reach of children. If the bag is placed over a child's head, it can block the mouth and nose and cause suffocation.

2. Set the humidifying pan and humidifying pan cover (Fig. 1).

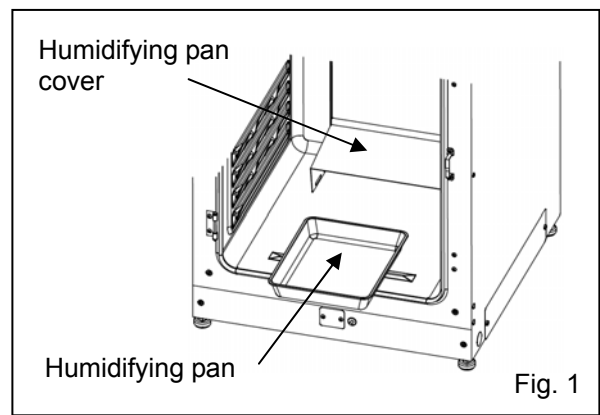

3. Set 4 trays (Fig. 2).

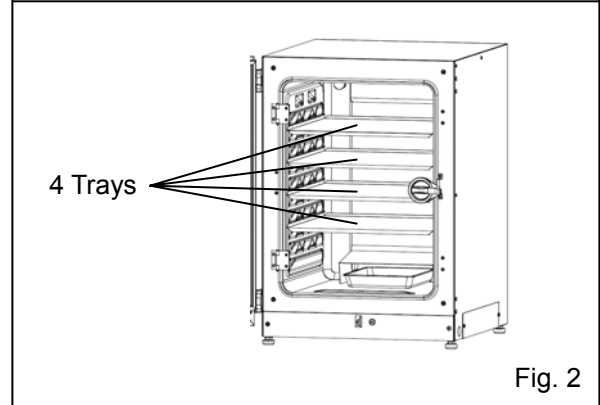

4. Adjust the leveling feet.

Adjust the leveling feet by turning them counterclockwise to level the incubator (Fig. 3)

Note: Incubating on a leaning tray may have a bad influence on the cultivation.

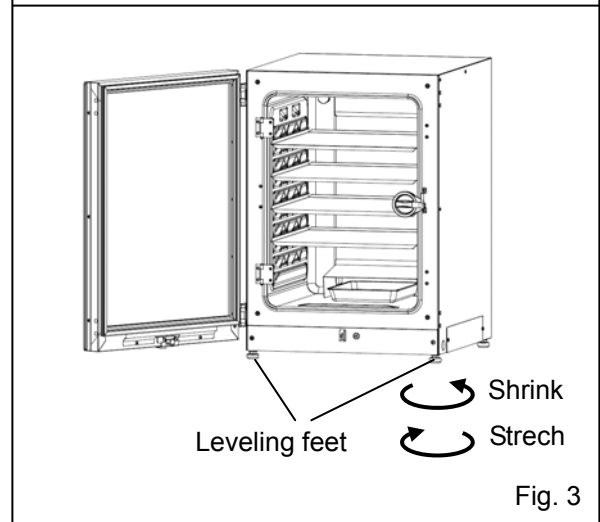

5. Ground the incubator.

Ground the incubator during installation to prevent electric shock in case the insulation is not sufficient. If there is no ground wire at the location, consult with qualified service personnel.

● When a ground must be installed

If a grounded 3-pole outlet is not available, then a ground must be installed. Consult with qualified service personnel.

⚠ WARNING

To prevent electric shock, **always ground the incubator**. If grounding is not possible, then have a ground installed by qualified personnel. If the incubator is not grounded, it may result in electric shock.

Never connect the ground wire to a gas pipe, water pipe, lightning rod, or telephone ground wire. Doing so may cause electric shock.

● Installing a ground fault circuit breaker

If using the incubator in the location with moisture or humidity cannot be avoided, then it is recommended that a ground fault circuit breaker be installed in the power supply circuit (i.e., the power supply at the incubator). Have the circuit breaker installed by qualified service personnel.

⚠ CAUTION

Do not climb on the incubator or place objects on top of it. Doing so may damage it or cause it to fall over, resulting in injury.

● In case of double stack

For stacking the incubators surely, refer to the procedure included with the optional double stacking bracket MCO-170PS or the stacking plate MCO-170SB.

Note: Two hooks are attached to the rear of the upper incubator. When stacking incubators, fix the upper incubator to the wall with these hooks and wire or chain (Fig. 4).

Note: When stacking the incubators on our CO₂ incubator or O₂/CO₂ incubator other than this product, use the stacking plate MCO-170SB. Refer to table 11 on page 90.

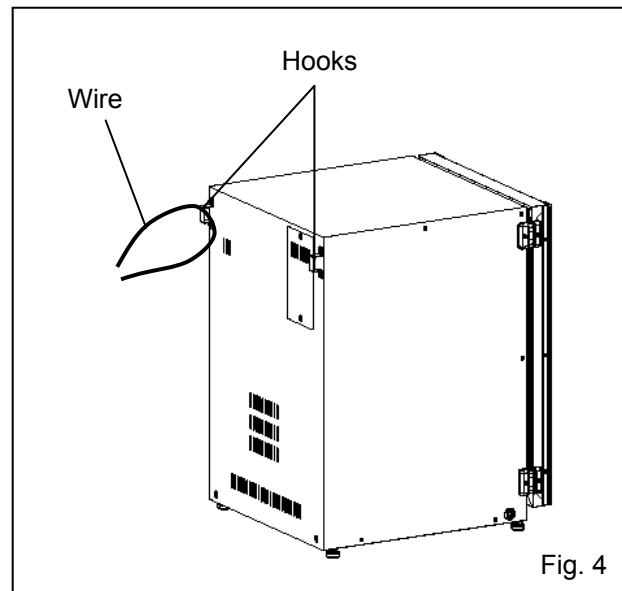

Fig. 4

● When the incubator is not in use

Empty the water from the humidifying pan and remove moisture from the chamber. Make sure that the chamber is completely dry before closing the doors. Failure to do so may result in damage.

● Before moving the incubator

Before moving the incubator, empty the water from the humidifying pan, disconnect the power supply plug from the outlet, and make sure that the cord will not be damaged. Failure to do so may result in electric shock or fire.

INSTALLATION

Connecting CO₂ gas cylinder

WARNING

When connecting a gas cylinder to the incubator, **confirm the gas type. Confirm that the connections are secure and that no gas will leak. Be sure to use the specified pressure.** Using an incorrect gas or pressure may result in explosion or fire, or in gas poisoning or oxygen deprivation due to gas leak.

Install the incubator in a location with adequate ventilation. If adequate ventilation cannot be provided, then install an alarm system using CO₂ and O₂ densitometers.

1. Get a CO₂ gas cylinder ready and install an optional gas regulator MCO-100L.

Note:

- Use a liquefied CO₂ gas cylinder (at least 99.5 % pure). The siphon (dip tube) type cannot be used.
- When MCO-100L is not available, install a gas regulator rated at 25 MPa(G) (250 kgf/cm²(G), 3600 psi(G)) for the primary side, and 0.2 MPa(G) (2 kgf/cm²(G), 30 psi(G)) for the secondary side.

2. Using a gas tube that is provided, connect the connecting port A for CO₂ gas pipe and the gas regulator of the CO₂ gas cylinder.

For details on installing the optional automatic CO₂ cylinder changeover kit (MCO-21GC), refer to page 70~72.

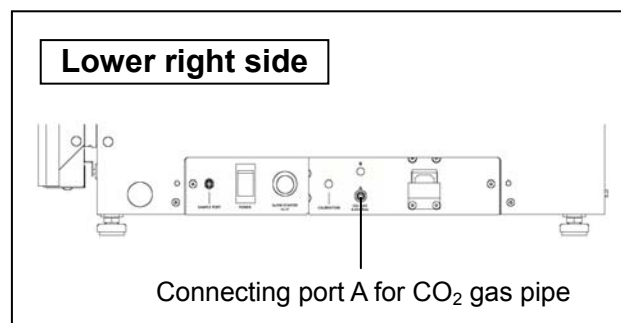

Note: If the CO₂ gas is supplied to multiple CO₂ incubators from a single gas cylinder, a CO₂ solid will be formed in the gas regulator. The gas regulator safety valve will operate, and there may be an explosive sound.

3. After connecting the gas tube, make sure that no gas is leaking.

4. Set the CO₂ gas on the secondary side to 0.03 MPa(G) (0.3 kgf/cm²(G), 4.3 psi(G)) for gas injection.

Note: As the pressure increases, the CO₂ gas density control range will increase. Excessive pressure may cause gas supply lines inside the incubator to come loose, which may result in gas poisoning or oxygen deprivation due to gas leak. If gas lines come loose, the incubator must be repaired.

5. When there is no CO₂ gas left and the CO₂ gas empty alarm is activated, replace the empty gas cylinder to a new one.

Note: When an optional gas auto changer MCO-21GC is installed, it switches the empty CO₂ gas supply line to the other automatically. Refer to page 70~72.

Note: The gas lines connected to the incubator will degrade over time. If any deterioration or abnormalities are found during inspection, replace the lines immediately.

BEFORE COMMENCING OPERATION

Initial cleaning method

Before using the incubator for the first time, clean dirt (tape residue, smear, etc.) from the chamber and the inner attachments thoroughly. To keep the chamber clean is essential to get the proper performance out of the incubator. Use the following steps to clean the incubator properly.

1. Remove the inner attachments, referring to "Removing inner attachments" on page 22.
2. Clean the removed inner attachments, the chamber inside walls and the inner door gaskets with a cloth or sponge soaked in neutral detergent, diluted by 5 % or less. (Undiluted detergent can damage the plastic components. For the dilution, refer to the instruction of the detergent.) (Fig. 1)

⚠ CAUTION

Do not use detergents or antiseptic solutions with acid, alkali, or chlorine. Doing so may cause discoloration, corrosion, or rusting.

Be careful to keep the diluted detergent or water out of the temperature sensor, the CO₂ gas injection port, the inner sample air access port, the fan motor shaft bearing, and the inner sample air outlet (Fig.2 ←). Also, do not wash the temperature sensor and the UV lamp using detergent. Doing so may cause failure. (Fig. 2)

3. Soak a gauze or unwoven cloth in distilled water and wring it tightly, and then wipe off the residual detergent thoroughly.
4. Wash the silicon caps (2 pcs) for the access port and the fan using the above mentioned detergent and rinse them with distilled water, and then autoclave them for sterilization (121 °C, 20 minutes).
5. Wipe up the inside walls and the inner attachments like trays thoroughly with a cloth or unwoven cloth soaked in alcohol for disinfection. Be careful not to leave any residue alcohol.
6. Reinstall the inner attachments correctly and securely, referring to "Installing inner attachments" on page 24.

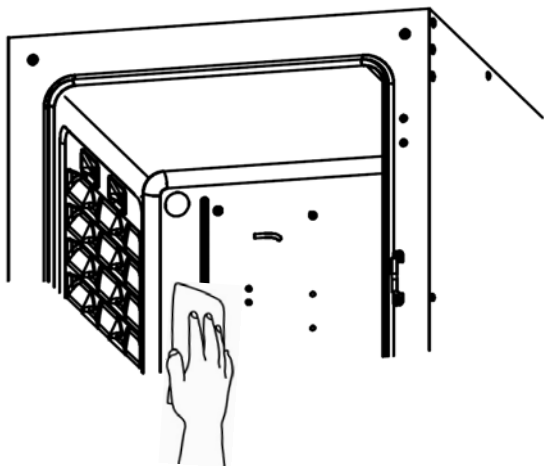

Fig. 1

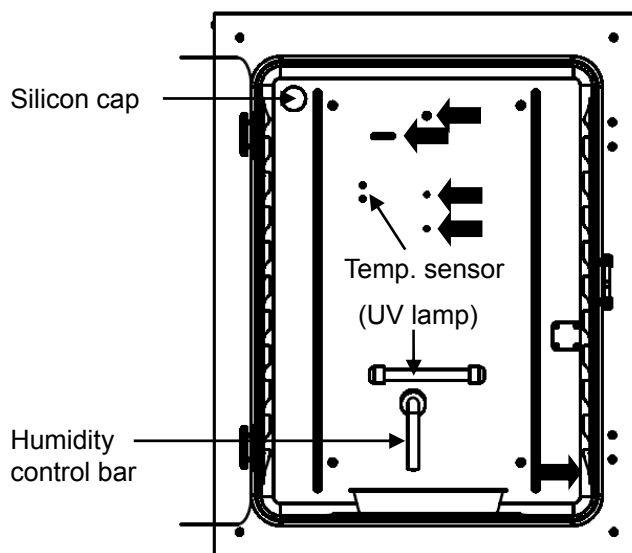

Fig. 2

BEFORE COMMENCING OPERATION

Removing inner attachments

CAUTION

Wear rubber gloves when performing maintenance on the chamber. Failure to wear gloves may result in cuts or abrasions from sharp edges or corners.

Always replace the inner attachments removed for the cleaning to keep the intended performance. Be careful not to damage the UV lamp in the duct (MCO-170AICUVH/170AICUV or when an optional UV system set MCO-170UVS is installed).

1. Turn OFF the power to the incubator.
2. Open the outer and inner doors and pull out all the trays (Fig. 1).

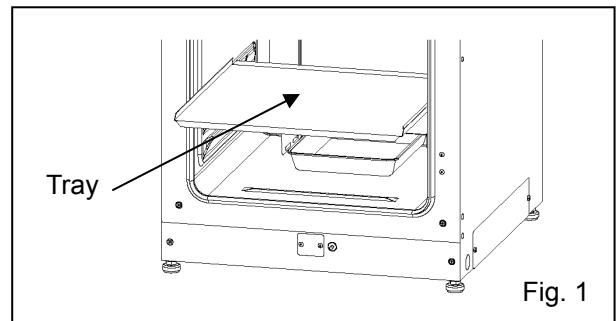

3. Pull out the humidifying pan (Fig. 2).

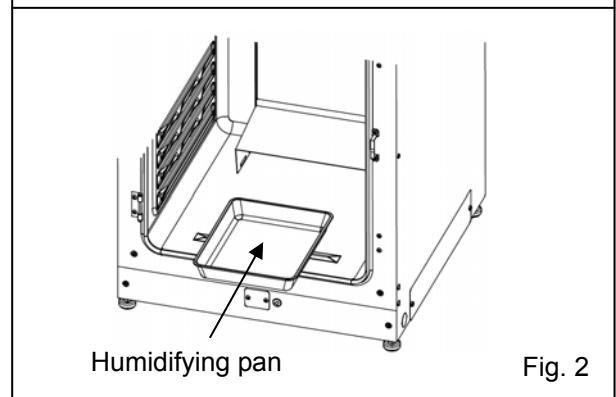

4. Pull out the humidifying pan cover (Fig. 3).

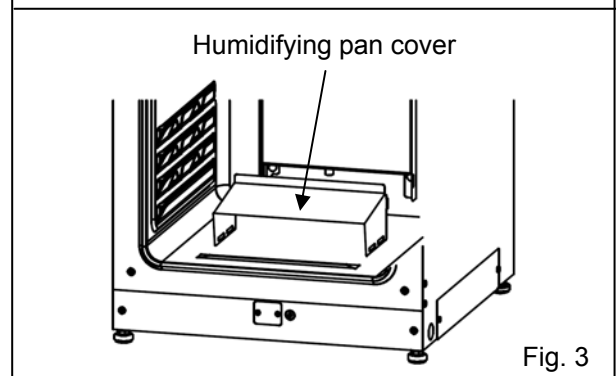

5. Pull out the fan cover (Fig. 4).

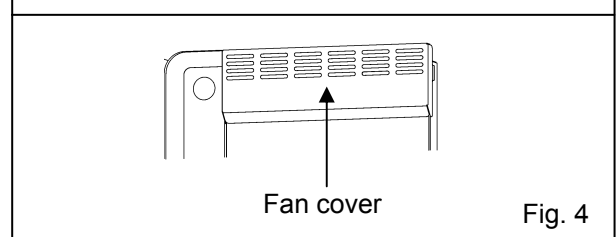

6. Lift the duct and remove it from the pins on the rear side. (Fig. 5)

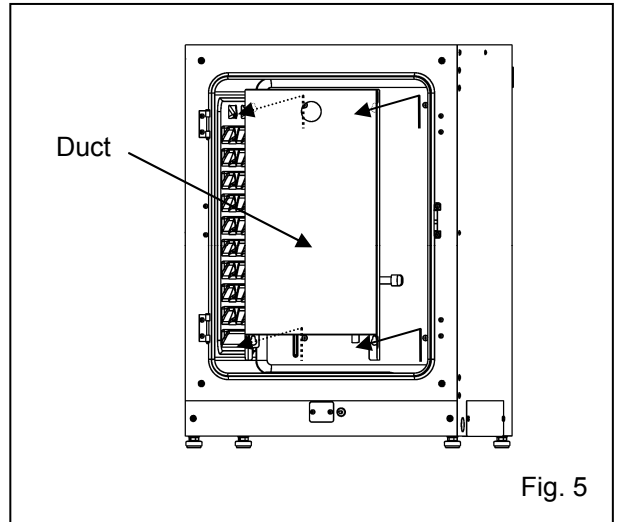

7. Pull out the fan (Fig. 6)

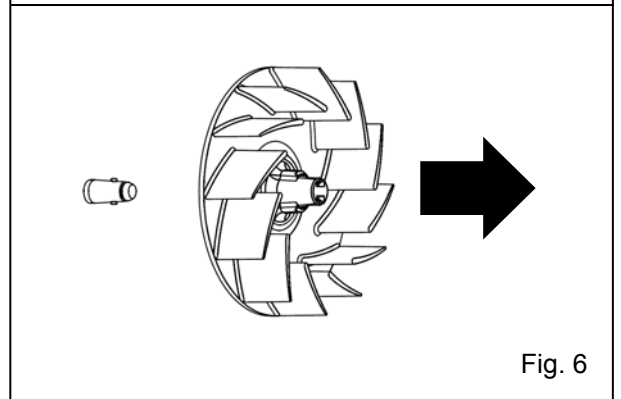

8. Remove the silicon caps of each access port from interior (Fig. 7) and exterior (Fig. 8).

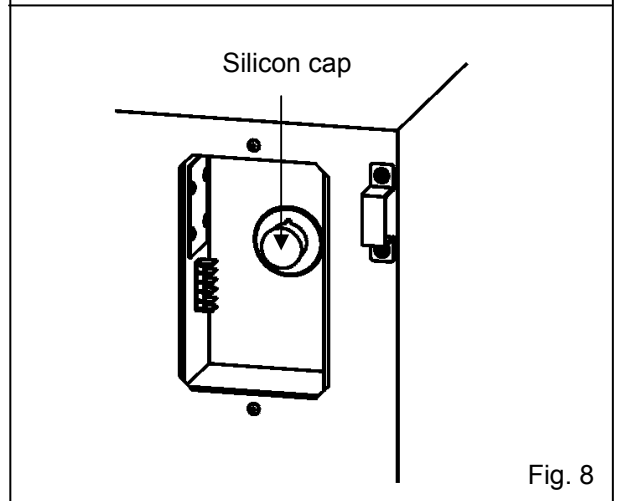
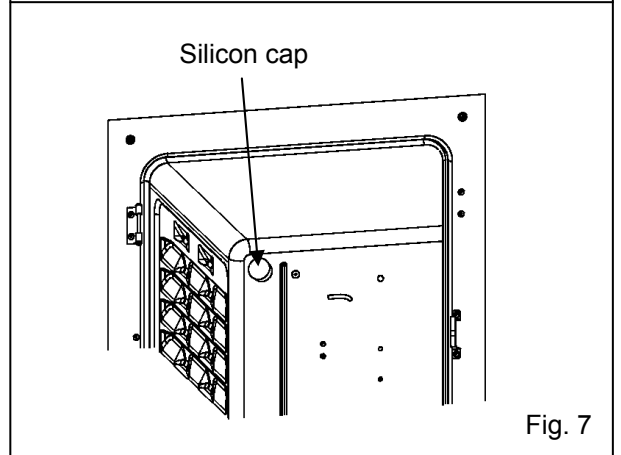

BEFORE COMMENCING OPERATION

Installing inner attachments

To re-install all the attachments, perform the procedure in reverse order from step 8 on page 23.

Note: When installing the fan, insert it to the motor shaft securely. Lightly turn and pull the fan manually to make sure that it does not touch the rear panel and is installed securely (Fig. 1).

⚠ CAUTION

If the fan is not inserted deep enough, the intended velocity performance cannot be achieved, and it may cause culture failure or insufficient decontamination.

Note: To install the duct, confirm 4 pins are securely installed in the 4 holes of the duct. (Fig. 2)

⚠ CAUTION

If the duct is fixed insecurely, the intended velocity performance cannot be achieved, which may cause culture failure or insufficient decontamination.

Note: When installing the fan cover, position the long hole of duct with the projection of fan cover and insert directly (Fig.3). Same applies for the humidifying pan cover.

The fan cover may lean by strongly pushing the head of it in the back. Make sure that there is no space in the lower fan cover after installing because the leaning fan cover may have a bad influence on the camber temperature distribution.

⚠ CAUTION

If the fan cover is fixed insecurely, the intended velocity performance cannot be achieved, which may cause culture failure.

Note: set the tray with only the front edge bent down. (Fig. 4)

① Position the center hole of the fan with the projection of the motor shaft. And insert it deeply.

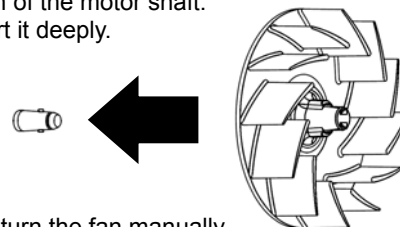

② Lightly turn the fan manually to make sure that it does not touch the rear panel.

③ Lightly pull the fan manually to make sure that it is installed.

Fig. 1

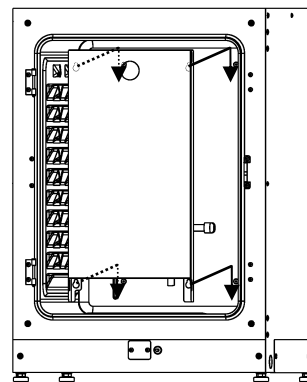
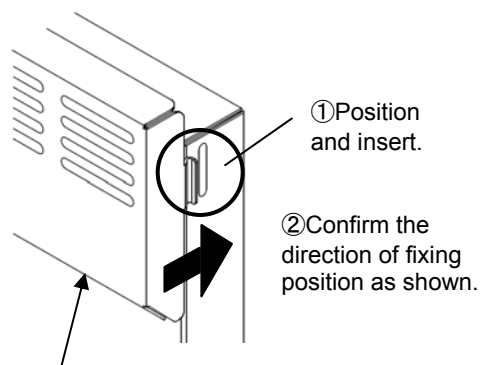

Fig. 2



① Position and insert.

② Confirm the direction of fixing position as shown.

③ Make sure that there is no space in the lower of fan cover.

Fig. 3

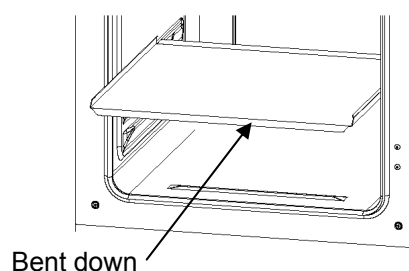
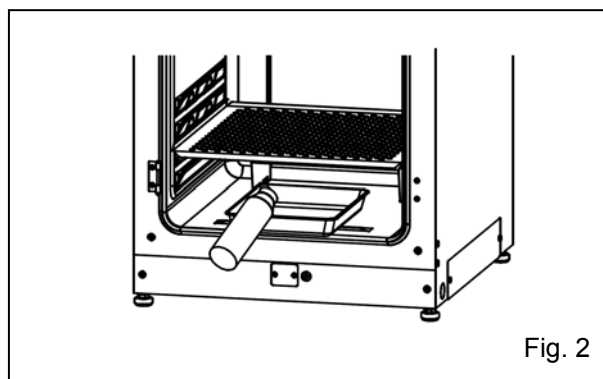
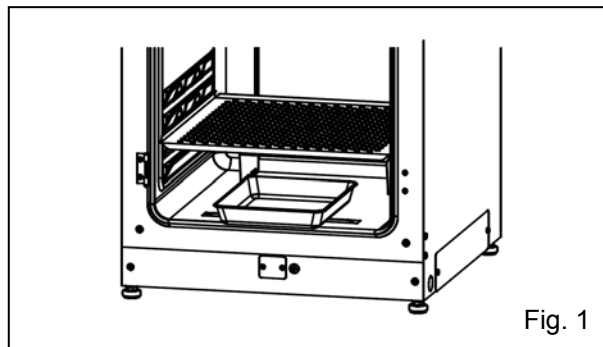

Fig. 4

Filling humidifying pan

Use the following procedure to fill the humidifying pan with water or to replace water in the humidifying pan.

1. Pull out the humidifying pan toward you. (Fig. 1)
2. Dispose of the remaining water in the humidifying pan and clean the humidifying pan with a diluted detergent. Then rinse it thoroughly with distilled water and wipe it with alcohol for disinfection.
3. Wipe all moisture from the bottom of the chamber.
4. Return the humidifying pan to the chamber and pour sterile distilled water (approx. 1.5 L, preheated to 37 °C). (Fig. 2)



Note:

- Preheat the water to 37 °C to be poured into the humidifying pan. Adding low-temperature water will lower the temperature and humidity in the chamber.
- Install the humidifying pan in a longitudinal direction as its shorter side is placed in the back.
- Refill the humidifying pan with water early when the volume of water is decreased.
- Mixing any reagent in the humidifying water may have a bad influence on the cultivation. Especially when using the UV lamp, do not use any reagent. Because the UV light may deteriorate the reagent mixed with the humidifying water.

5. Set the humidifying pan with the inner side flush against the back, and close the inner door and the outer door.

Note: Set the humidifying pan with the inner side flush against the back. The humidity control bar in the duct keeps at low temperatures and inner moisture is recondensed. Slide the humidifying pan down right under the humidity control bar, otherwise the recondensed water drops will directly fall to the chamber bottom and will pool in the chamber bottom.

When the pooled water evaporates, it may leave a white mark on the chamber bottom. This is not a malfunction. Wipe it off with alcohol-soaked gauze or unwoven cloth. When the mark cannot be removed, scrub the mark off with using a cream cleanser.

FOR BETTER CULTIVATION

Precautions for cultures

- **Leave space between culture containers.**

Always leave space for ventilation between culture containers (Petri dishes, flasks, etc.). Inadequate spacing may result in uneven temperature distribution and CO₂ gas density.

- **Do not place harmful materials in the chamber.**

Never place samples that release acidic, alkali, or corrosive gas in the chamber. Doing so may cause damage resulting from discoloration or corrosion.

- **Close the inner door.**

Always close the inner door before closing the outer door. Failure to close the inner door will adversely affect performance even if the outer door is closed.

- **Open and close the doors gently.**

Always open and close the doors gently. Closing the doors forcefully may cause spillage of the culture medium, incomplete closing, or damage to the gasket. Before opening the inner door, check through the glass to confirm that the UV lamp is OFF (if the MCO-170AICUVH/170AICUV or the optional MCO-170UVS is installed).

- **Be careful when closing the outer door.**

Use the handle when closing the outer door. Holding the door in other places may cause injury by getting fingers caught in the door. Do not lean on the outer door. Doing so may result in injury from the outer door coming loose or the incubator falling over, or it may cause current leakage or electric shock.

- **Be careful of the inside of the outer door.**

The inside of the outer door may become hot.

- **Avoid using excessive force on the inner door.**

Do not put your hand on the glass, poke it with sharp objects, or apply strong force. Doing so may result in injury from breaking the glass.

- **Check the cause of any alarm buzzer.**

If an alarm buzzer sounds while the incubator is in use, immediately check the cause of the alarm. For details on what may cause an alarm buzzer to sound, refer to page 78~80.

- **Vibration of a shaker.**

When stacking incubators and operating the shaker for CO₂ incubator MIR-S100C in the chamber of the CO₂ incubator, it may have a bad influence on the other.

Preventing contamination

To prevent contamination of the chamber, select a suitable installation site.

- **Avoid locations with high temperatures or humidity.**

Avoid locations with high temperatures or humidity, because of a greater presence of microorganisms in the air.

- **Avoid locations with passers-by or drafts.**

Avoid locations near doors, air conditioners, fans, etc., where passers-by or drafts can facilitate the entry of microorganisms into the chamber.

- **If possible, use a cleanroom.**

To achieve a better culture, it is recommended that a cleanroom be used if one is available.

- **Use clean containers.**

The greatest cause of contamination is dirty containers for cultures. Be careful not to get containers or trays dirty when taking them in and out.

- **Keep the chamber clean.**

Wipe off any fingerprints. If water spills from the humidifying pan, or if the doors are left open for a long time, condensation may form on the inside of the doors. If that occurs, wipe off the condensation with a dry sterile gauze. In particular, clean and disinfect the chamber if the culture medium is spilled. For details, refer to "ROUTINE MAINTENANCE" on page 77.

- **Use sterile distilled water in the humidifying pan.**

Always use sterile distilled water in the humidifying pan. Do not use ultrapure water, because it may cause red rust-like particles in the humidifying pan. Clean the humidifying pan once a month.

- **Keep the incubator out of direct airflows from air conditioners or fans.**

Cool airflow from an air conditioner may cause condensation and lead to possible contamination.

CORRECT OPERATION

Use the following procedure to start trial operation or actual operation of the incubator.

1. Install the incubator correctly, referring to “INSTALLATION” on page 16 to 20.
2. Remove the packing materials from the chamber and inner attachments. Clean and disinfect the chamber and all the inner attachments, referring to “ROUTINE MAINTENANCE” on page 77.
3. Add approximately 1.5 L of sterile distilled water to the humidifying pan. (Refer to page 25.)
4. Connect the removal power supply cord that is provided, to the port on the lower right side.
Note: 2 removal power supply cords are provided.

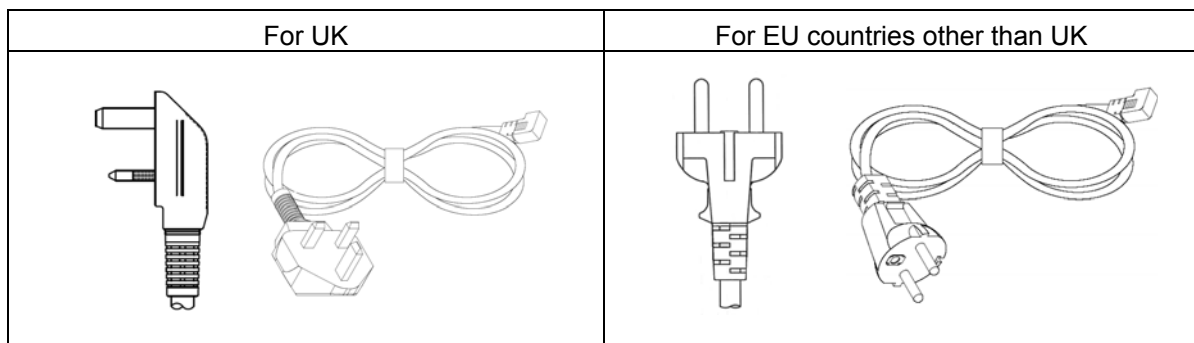

5. Connect the removable power supply cord to the outlet.
6. Turn ON the power switch on the lower right side of the incubator.
7. (MCO-170AICUVH/170AICUV or when an optional UV system set MCO-170UVS is installed.) Set the frequency of a power supply on the LCD touch panel (Refer to page 57 ~58).

WARNING

Always use the removal power supply cord that is provided. Other power supply cord may cause electric shock or fire.

- **The provided removal power supply cord is only for this product.**

Never use it for any other products.

- **When the incubator is not in use**

Empty the water out of the humidifying pan and remove moisture from the chamber. Make sure that the chamber is completely dry before closing the doors. Failure to do so may result in damage.

- **Before moving the incubator**

Before moving the incubator, empty the water out of the humidifying pan, disconnect the power supply plug from the outlet, and make sure that the cord will not be damaged. Failure to do so may result in electric shock or fire.

BASIC OPERATION ON LCD TOUCH PANEL

● Operation from Menu key

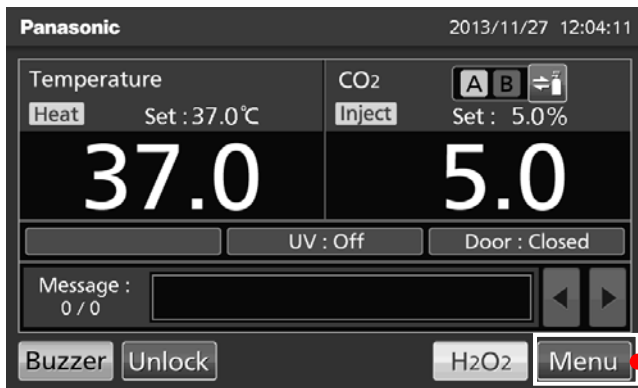

Menu screen

Page

◆ Set	■ Stand-by Setting screen	(Setting)	Temp., CO ₂ density, high limit temp. alarm Auto lock ON/OFF* ¹	32~33 67~69
◆ Log	■ Log screen			
	◆ Chart	■ Chart screen		
		◆ Actual Temp.	(Display) Chamber temp. log graph (can be exported)	41~43
		◆ Actual CO ₂ Level	(Display) CO ₂ density log graph (can be exported)	41~43
		◆ Door Opening	(Display) Outer door opening log graph (can be exported)	41~43
	◆ Data Export	■ Export screen		
		◆ Actual Temp.	(Export) Chamber temperature log	44~46
		◆ Actual CO ₂ Level	(Export) CO ₂ density log	44~46
		◆ Door Opening	(Export) Outer door opening log	44~46
		◆ Setting	(Setting) Log interval	40~41
		◆ Alarm	(Display) Alarm log (can be exported)	47~48
		◆ Alarm Export	(Export) Alarm log	49~51
◆ Key Lock	■ Key Lock screen	(Setting)	Key lock ON/OFF, password	34~36
◆ Tools#1	■ Tools#1 screen			
	◆ Temp./CO ₂ Calibration		Don't push (See Next page)	
	◆ Alarm Setting #1	(Setting)	Temp. alarm, CO ₂ density alarm	37~38
	◆ Alarm Setting #2	(Setting)	Alarm delay, ring back, remote alarm etc	37~39
	◆ UV Setting* ²	(Setting)	UV timer, power supply frequency	56~58
		(Operate)	Lighting UV lamp for 24 hours	59~60
	◆ STD Gas Setting* ³	(Setting)	CO ₂ density of standard gas	74~75
	◆ STD Gas Calibration* ³	(Operate)	Calibration of CO ₂ density by STD gas	75~76
◆ Tools#2	■ Tools#2 screen			
	◆ Date & Time	(Setting)	Date, time	52
	◆ Brightness/Sleep	(Setting)	Brightness, sleep ON/OFF etc	53~54
	◆ DAQ Setting* ⁴	(Setting)	DAQ system ON/OFF, ID, speed etc	55

*1: MCO-170AICUVH or when an optional electric lock MCO-170EL is installed.

*2: MCO-170AICUVH/170AICUV or when an optional UV system set MCO-170UVS is installed.

*3: When an optional STD gas autocalibration kit MCO-SG is installed.

*4: Only when using an optional software product Data acquisition system MTR-5000.

Note: Service key is not available. (Qualified engineer only)

BASIC OPERATION ON LCD TOUCH PANEL

Note: On the Tools #1 screen, by mistakenly pressing Temp./CO₂ Calibration key, Temp./CO₂ Calibration screen is displayed.

When this screen is displayed, press Back key to return to the Tools #1 screen, or press Top key to return to the Top screen.

When these settings on this screen are changed, inaccurate temperature or CO₂ density may be displayed.

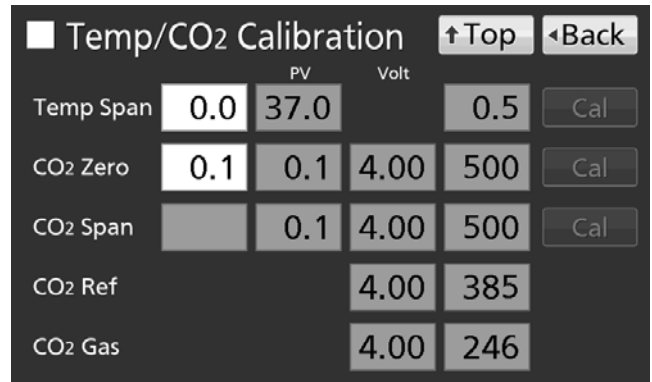

•Operation from other than Menu key

◆CO₂ gas supply line select key: (Operate) Manual changeover between CO₂ gas supply line A and B (Page 73)

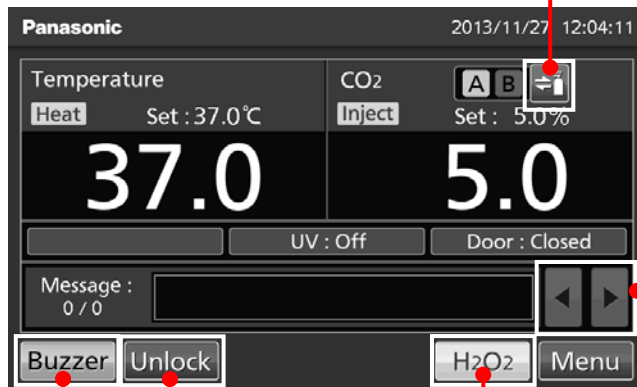

◆Message select key: (Operate) Changing some messages

◆H₂O₂ key*⁵: (Operate) H₂O₂ decontamination (Page 61~66)

◆Unlock key*⁶: (Operate) Unlock the outer door. (Page 67~69)

◆Buzzer key: (Operate) Silencing the buzzer (Alarm is not canceled except for some alarms; page 79)

*5: Under any of the following conditions only.

- When an H₂O₂ generator MCO-HP is installed in the MCO-170AICUVH.
- When all H₂O₂ generator MCO-HP, H₂O₂ decon board MCO-170HB and electric lock MCO-170EL in the MCO-170AICUV.
- When all UV system set MCO-170UVS, H₂O₂ generator MCO-HP, H₂O₂ decon board MCO-170HB and electric lock MCO-170EL in the MCO-170AIC.

*6: For the MCO-170AICUVH or an optional electric lock MCO-170EL is installed, when the auto lock function is ON.

BASIC PARAMETERS

Numerical input to input window

On each screen in the LCD touch panel, it may be necessary to input numerical values on the numerical input box.

1. By pressing numerical input box, input window is displayed.

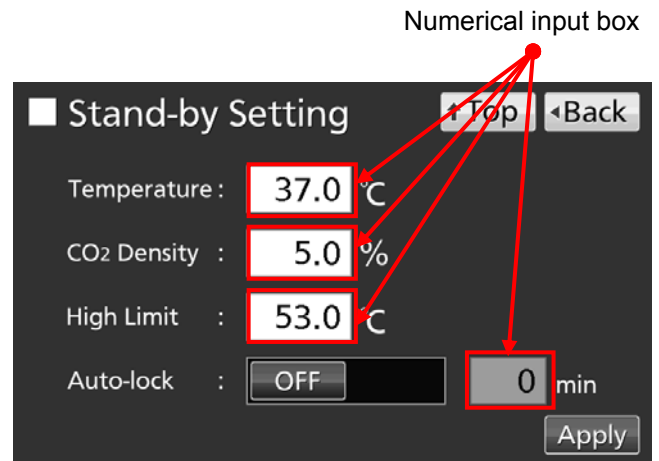

2. Press Numerical key or Up/Down key to input numerical value, and press OK key.

●key description

•Numerical key (0~9):

Input numerical values

•Up/Down key (▲/▼):

Increases or decreases the numerical value displayed in the numerical input box.

•Clear key:

Deletes the numerical value displayed on the numerical input box

•Cancel key:

Stops inputting on the numerical input box and closes the input window.

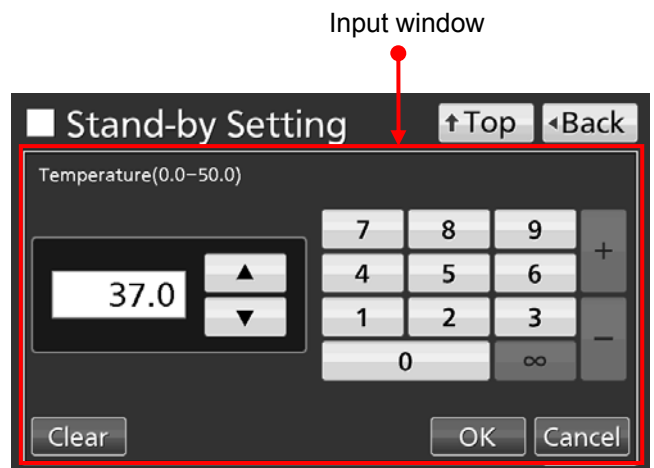

Note: While the input window is open, it is not possible to operate Top key and Back key.

Note: Up/Down key may not be displayed.

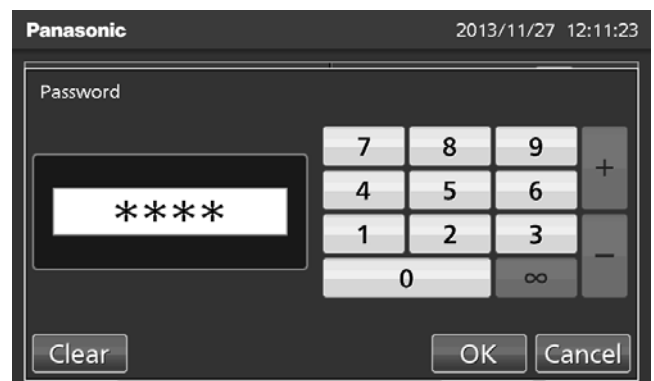

BASIC PARAMETERS

Setting temperature, CO₂ density and high limit temperature alarm

Set the chamber temperature, the CO₂ density and the temperature of the high limit temperature alarm for normal operation according to the following procedure. The incubator automatically starts operation using these settings after power-on.

1. Press Menu key to lead the Menu screen.

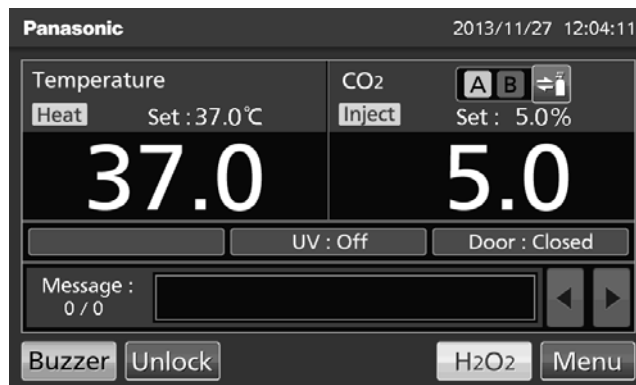

2. Press Set key to lead the Stand-by Setting screen.



3. Input each parameter. Press Apply key to save the input value. The display returns to the Menu screen.

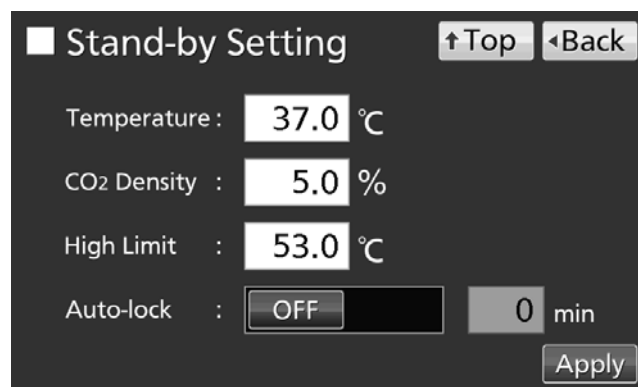

● Each parameter setting

• Temperature: Set value of chamber temperature.

Settable range: 0.0 °C~50.0 °C, factory setting: 37.0 °C。

• CO₂ Density: Set value of chamber CO₂ density. Settable range: 0.0 %~20.0 %, factory setting: 0.0 %。

• High Limit: The high limit temperature alarm is different from the Automatic set temperature alarm (page 37), and it is independent temperature alarm. In case the chamber temperature exceeds the temperature of the high limit temperature alarm, this alarm is activated.

Settable range: 20.0 °C~53.0 °C, factory setting: 53.0 °C。

• Auto-lock: Refer to page 67~69.

Refer to page 78~80 for detail of each alarm.

Note:

• When operating the incubator for the first time or after not using it for an extended period of time, operate it for at least about 4 hours until the chamber temperature and the CO₂ sensor are stable after setting the chamber temperature to the desired temperature and setting the CO₂ density to 0 %. Then change the setting to the desired CO₂ density.

• Set the temperature of the high limit temperature alarm after the chamber temperature is stable at the set value.

• Set the high limit temperature alarm to at least 5 °C higher than the chamber set temperature.

4. On the Menu screen, press Back key to return to the Top screen.

BASIC PARAMETERS

Setting key lock

1. Press Menu key to lead the Menu screen.

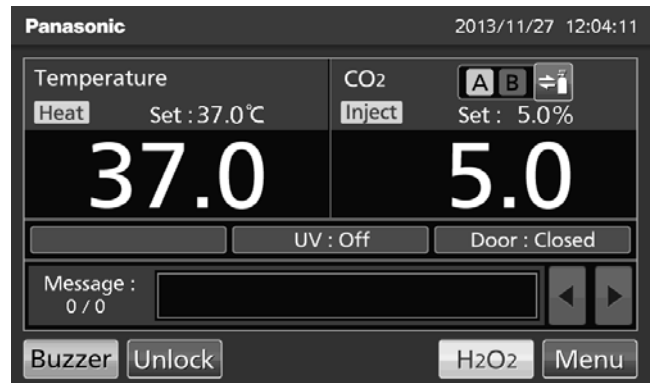

2. Press Key Lock key to lead the Key Lock screen.



3. On the Key Lock screen, it is possible to set each key lock. Press Apply key to change key lock ON and to save the password. The display returns to the Menu screen.

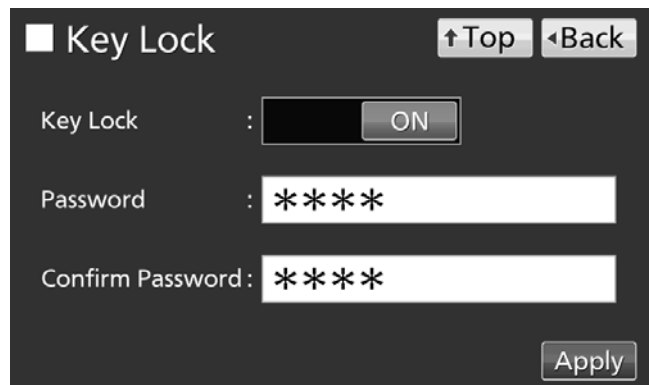

● Each setting of key lock

- Key Lock: By holding Key Lock slide key and sliding it to the right, Key Lock turns to ON.
- Password: The password (Max. 6 digits) inputted here is the release password of Key Lock.
- Confirm Password:

To prevent erroneous input, input the same password to Password input box. When inputting different password, Notice dialog box is displayed. Press OK key and input the correct password.

Note: It is possible to input the 6 digit password at the maximum. By inputting the 7th (8th) digit, the 1st (2nd) digit is deleted.

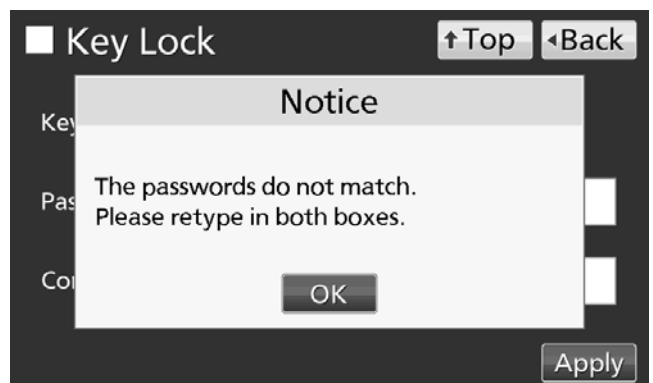

Note:

- For the MCO-170AICUVH or an optional electric lock MCO-170EL is installed to the MCO-170AICUV/170AIC, when the auto lock function is ON, the release password of Keylock is required to unlock the auto locked outer door (refer to page 68).
- Manage the release password of Keylock properly.

4. On the Menu screen, press Back key to return to the Top screen.

●Operation for Kelock-ON

•To press neither CO₂ gas supply line select key nor Buzzer key, Password input box is displayed, and input of password is required.

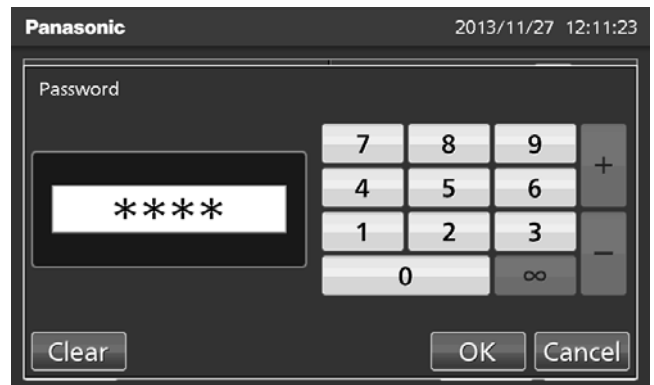

•When the inputted password is incorrect, Notice dialog box is displayed. Press OK key, and then input the correct password.



BASIC PARAMETERS

Removing key lock

1. By pressing Menu key, the Password input window is displayed.

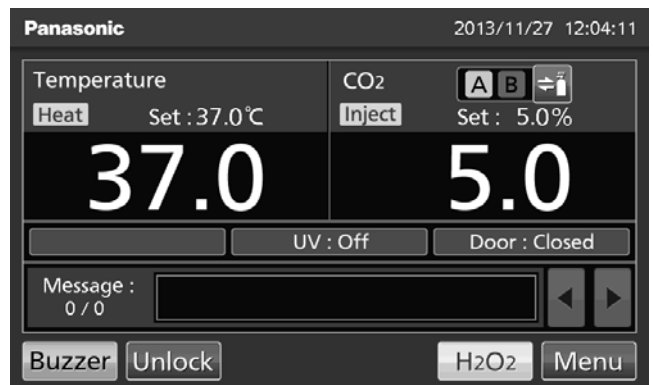

2. On Password input box, input the set release password of Key lock, and press OK key to lead the Menu screen.

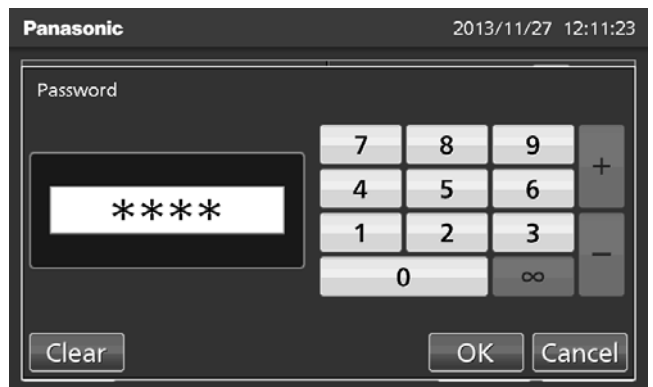

3. Press Key Lock key to lead the Key Lock screen.



4. On the Key Lock screen, by holding Key Lock slide key and sliding to the left, change to OFF. Press Apply key to turn the key lock OFF. The display returns to the Menu screen.

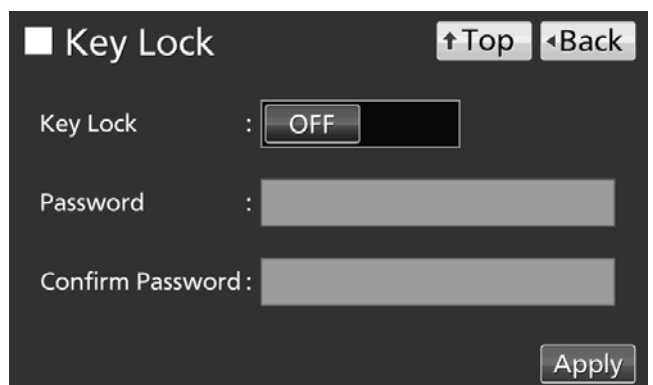

5. On the Menu screen, press Back key to return to the Top screen.

ALARM PARAMETERS

1. Press Menu key to lead the Menu screen.

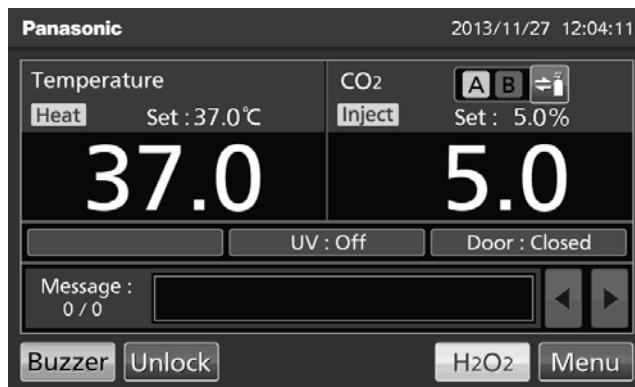

2. Press Tools #1 key to lead the Tools #1 screen.



3. On the Tools #1 screen,

- Press Alarm Setting #1 key to lead the Alarm Setting #1 screen, it is possible to set automatic set temperature alarm and automatic set CO₂ density alarm (go to procedure 4).

- Press Alarm Setting #2 key to lead the Alarm Setting #2 screen, it is possible to set alarm delay, door alarm delay, ring back and remote alarm (go to procedure 5).

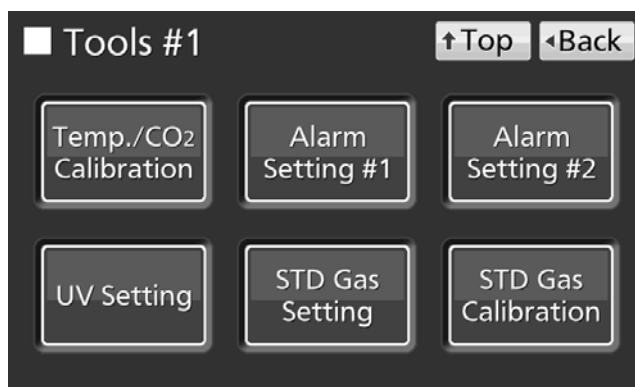

4. On the Alarm Setting #1 screen, input each parameter. Press Apply key to save the input value. The display returns to the Tools #1 screen.

- Each parameter setting

- Temp. Alarm:

When the chamber temperature exceeds the scope, the set temperature \pm the set value of Automatic set temperature alarm, the alarm is activated. Settable range: $\pm 1.0\text{ }^{\circ}\text{C} \sim \pm 5.0\text{ }^{\circ}\text{C}$, factory setting: $\pm 1.0\text{ }^{\circ}\text{C}$.

- CO₂ Alarm:

When the chamber CO₂ density exceeds the scope, the set CO₂ density \pm the set value of Automatic set CO₂ density alarm, the alarm is activated. Settable range: $\pm 0.5\% \sim \pm 5.0\%$, factory setting: $\pm 1.0\%$.

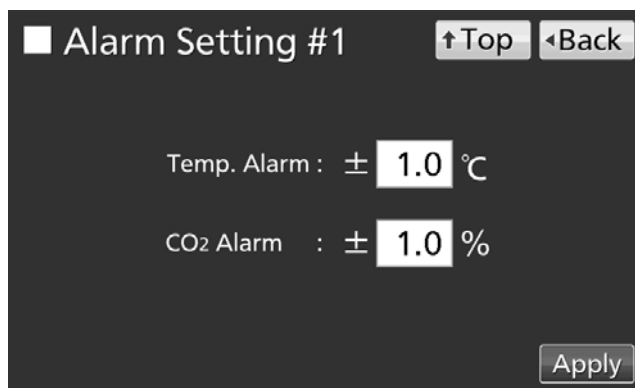

ALARM PARAMETERS

5. On the Alarm Setting #2 screen, it is possible to set each alarm. Press Apply key to save the input value and setup. The display returns to the Tools #1 screen.

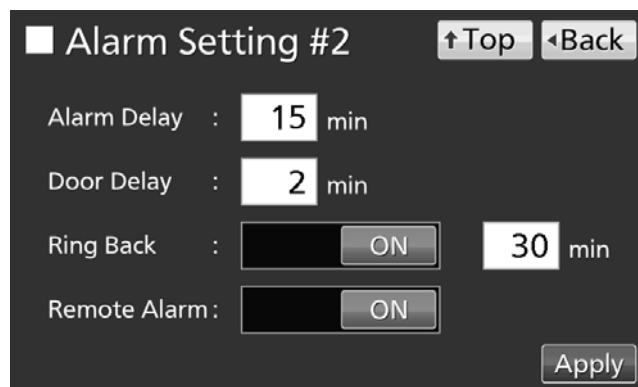

● Each setting

• Alarm Delay:

The function is that when the incubator is in the alarm state of Automatic set temperature or of Automatic set CO₂ density, the alarm buzzer will sound after the alarm delay set time passed. Settable range: 0 minute~15 minutes, factory setting: 15 minutes.

Note: When the incubator is recovered from the alarm state within the alarm delay time, the buzzer doesn't sound after the elapse of the alarm delay.

• Door Delay:

The function is that when the incubator is in the alarm state of door, the alarm buzzer will sound after the alarm delay set time passed. Settable range: 1 minute~30 minutes, factory setting: 2 minutes.

Note: When the incubator is recovered from the alarm state within the door alarm delay time, the buzzer doesn't sound after the elapse of the door alarm delay.

• Ring Back:

The function is that the alarm buzzer sounds again when the alarm state still continues after the alarm delay set time passed even though the alarm buzzer was stopped by pressing Buzzer key. By holding and sliding Ring Back slide key to the right, the Ring Back is turned to ON. Settable range: 1 minute~99 minutes, factory setting: 30 minutes.

Note: At Err01 (CO₂ gas cylinder empty), Err11•12 (CO₂ sensor error), Err18 (UV lamp failure) and Door alarm, the alarm is not re-activated because the alarm itself is deactivated by pressing Buzzer key (refer to page 78 and 79).

• Remote Alarm:

The function is that the remote alarm is continued even though the buzzer is stopped by pressing Buzzer key. By holding and sliding Remote Alarm slide key to the right, the Ring Back is turned to ON (not in conjunction with Buzzer key). Factory setting: ON.

6. (From procedure 4 and 5) Press Top key to return to the Top screen.

●At the alarm state

• While the incubator's alarm is being activated and the buzzer is being sounding, the buzzer is silenced by pressing Buzzer key. For the behavior at the time of pressing Buzzer key and the re-activation of alarm, under each setting condition, refer to Table 5-7 on page 79.

Resolve the cause of the alarm in reference to page 78-80 because the alarm itself is not deactivated by pressing Buzzer key except for some alarms.

Note: The buzzer for the high limit temperature alarm can't be silenced.

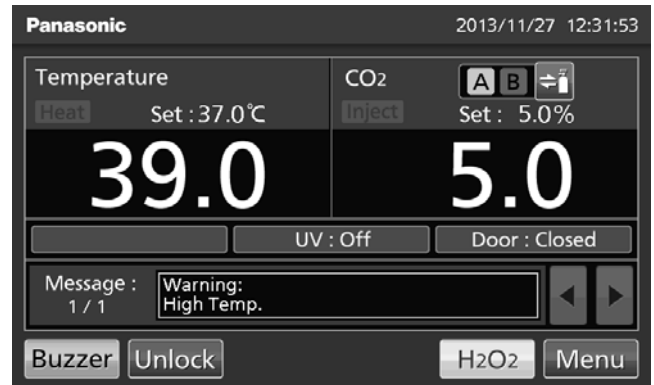

OPERATION/ALARM LOG

Setting log interval

The incubator is equipped with a function of saving operation log data (chamber temperature, CO₂ density and open/close state of outer door). Use the following procedure to set the log interval (interval of acquiring the operation log).

1. Press Menu key to lead the Menu screen.

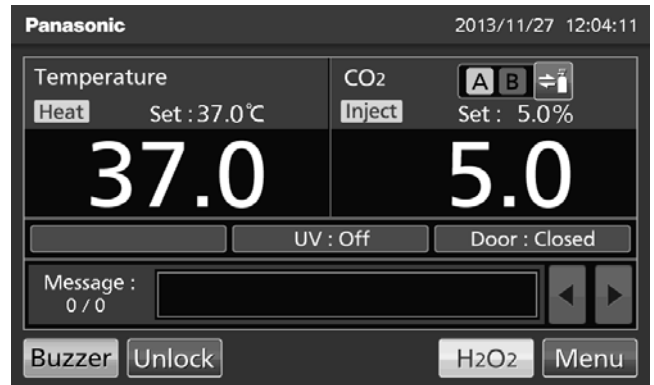

2. Press Log key to lead the Log screen.



3. Press Setting key to lead the Setting screen.



- On the Setting screen, input Log Interval. Press Apply key to save the input value. The display returns to the Log screen.
 Settable range: 2 minutes~30 minutes
 Factory setting: 6 minutes.



Note: Relation between log interval and the estimated amount of data that can be saved

- Log interval=2 minutes: Approx. 46 days
- Log interval=6 minutes: Approx. 135 days
- Log interval=30 minutes: Approx. 664 days

When saving data more than the above, and the data is overwritten and the old data is deleted.

- Press Top key to return to the Top screen.

Displaying operation log

Operation log saved in the incubator can be displayed graphically on the LCD touch panel.

- Press Menu key to lead the Menu screen.

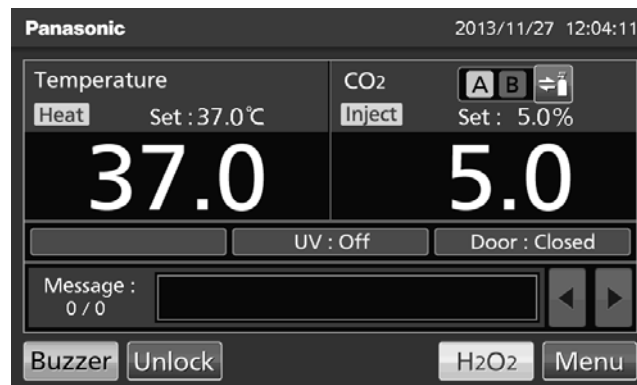

- Press Log key to lead the Log screen



OPERATION/ALARM LOG

3. Press Chart key to lead the Chart screen.



4. On the Chart screen, input the date (year / month / day) of the operation log you want to display graphically.

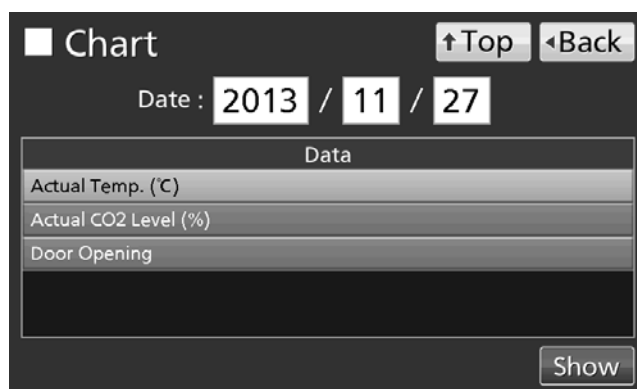

5. On the Chart screen, by pressing Show key after pressing the item you want to display graphically, the graph of each operation log is displayed.

- Actual Temp.:
Chamber temperature log graph
(Go to procedure 6)
- Actual CO2 Level:
CO₂ density log graph
(Go to procedure 7)
- Door Opening:
Open/close state of outer door log graph
(Go to procedure 8)

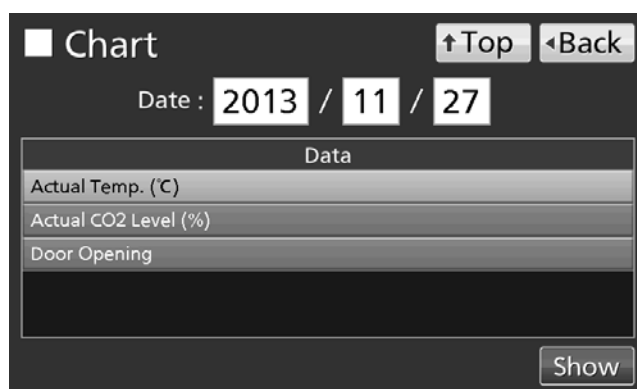

6. Actual Temp. log graph is displayed.

- Press Back key to return to the Chart screen.
- Press Top key to return to the Top screen.

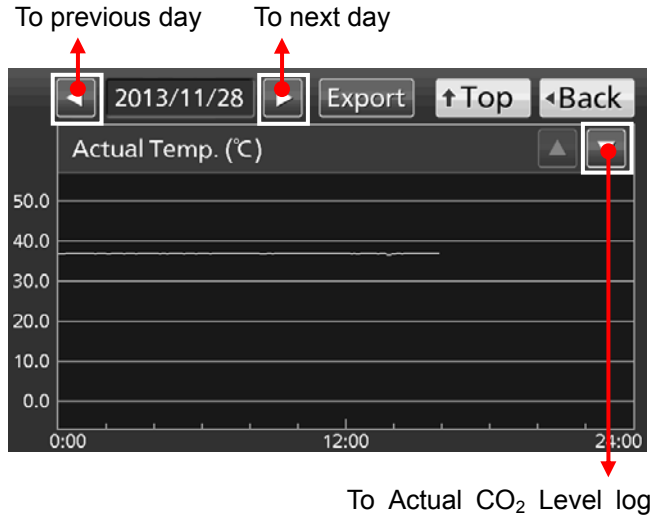

7. Actual CO₂ Level log graph is displayed.

- Press Back key to return to the Chart screen.
- Press Top key to return to the Top screen.

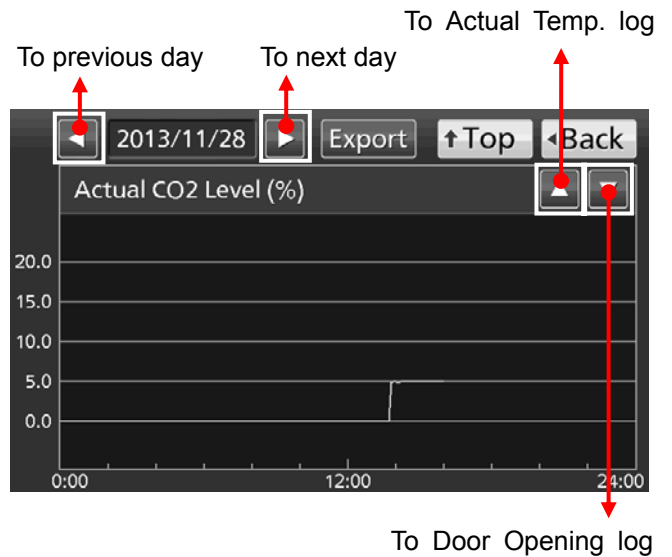

8. Door Opening log graph is displayed.

- Press Back key to return to the Chart screen.
- Press Top key to return to the Top screen.

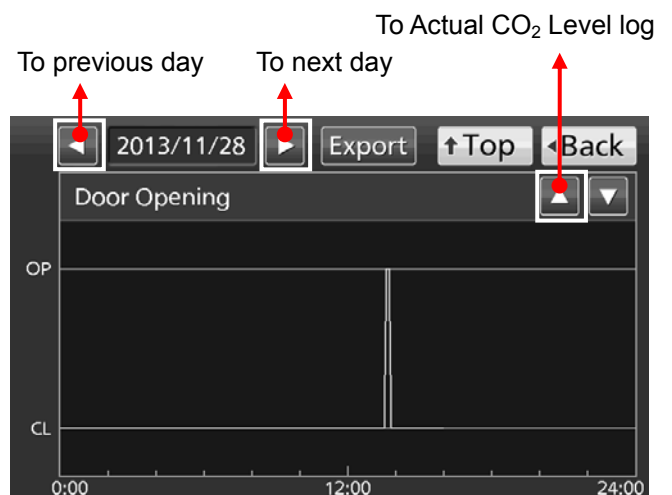

Note: The error of about 1 minute may be observed during a month. Refer to page 52 for the procedure of setting time.

OPERATION/ALARM LOG

Exporting operation log

Operation log data saved in the incubator can be exported in CSV format to the USB memory inserted into the USB port.

1. Insert the USB memory into the USB port.

Note: It is not possible to use a USB memory with security functions that requires entering password.

2. Press Menu key to lead the Menu screen.

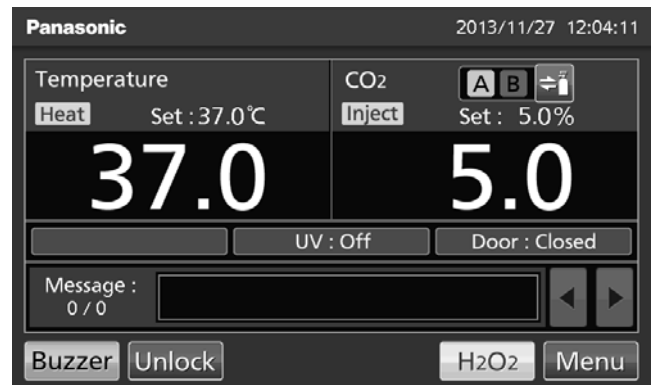

3. Press Log key to lead the Log screen.



4. Press Data Export key to lead the Export screen.



5. On the Export screen, select the time period you want to export.

•To export the saved operation log data over the entire period, press All radio button.

•To export the operation log data of a specified date, press 1 Day radio button and input the date (year / month / day) of the operation log data you want to export

Note: The error of about 1 minute may be observed during a month. Refer to page 52 for the procedure of setting time.

6. On the Export screen, select the type of operation log data you want to export.

•To export all types of operation log data, press All Ch key.

•To export only operation log data you want to export, select operation log data you want to export, and then press Selected Ch key.

•Actual Temp.: Chamber temperature log data

•Actual CO2 Level: CO₂ density log data

•Door Opening: Open/close state of outer door log data

Note: When no USB memory is inserted into the USB port, Notice dialog box is displayed. Press OK key, and then insert a USB memory into the USB port.



OPERATION/ALARM LOG

Note: When the specified operation log data doesn't exist, Notice dialog box is displayed. Press OK key, and then re-specified according to procedure 4 and 5.

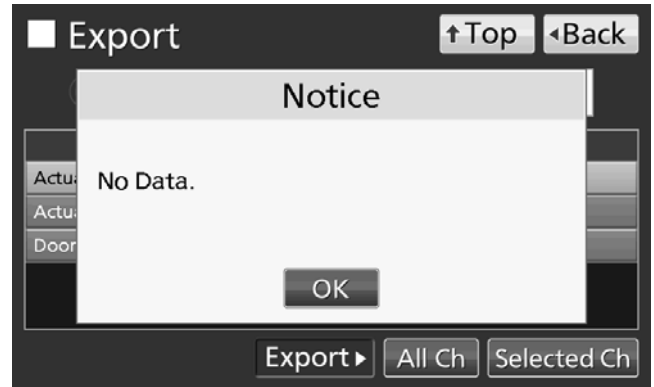

7. When the export is complete, Information dialog box is displayed. Press OK key.

Note: Even after the export of operation log data is complete, operation log data saved in the incubator are not deleted.



8. Remove the USB memory from the USB port.

Note: The log folder is created in the USB memory, and the exported file is saved in it in CSV format. The exported file name is in date (8 digits) - type of data format.

(e.g.) When exporting all types of data using All (from Oct. 1st, 2013 to Jan. 1st, 2014):

20131001-20140101_AllCh.csv

(e.g.) When exporting Actual Temp. using 1 Day (Jan. 1st, 2014):

20140101_Temp.csv

9. Press Top key to return to the Top screen.

Displaying alarm log

The incubator is equipped with a function of saving alarm log data (Max. 256 logs). Alarm log saved in the incubator can be displayed graphically on the LCD touch panel

Note: When saving alarm logs more than 257, the oldest alarm log is deleted, and then overwritten.

1. Press Menu key to lead the Menu screen.

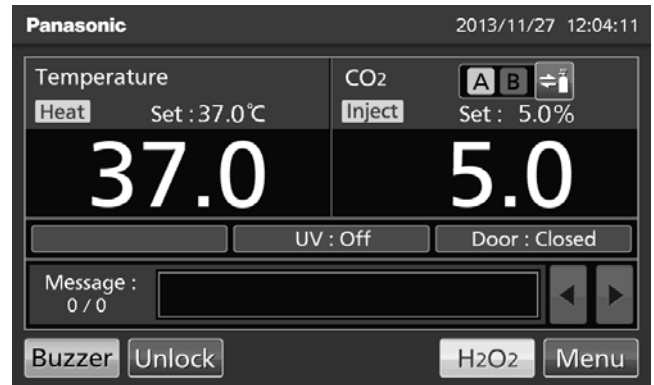

2. Press Log key to lead the Log screen.



3. Press Alarm key to lead the Alarm screen.



OPERATION/ALARM LOG

4. On the Alarm screen, the newest 7 days' alarm logs (containing that day) are displayed.

Note: When the number of applicable alarm log is 6 or more, by pressing the top (▲) or the bottom (▼) log, the log table currently displayed scrolls and hidden alarm logs can be seen.

- Press Back key to return to the Log screen.
- Press Top key to return to the Top screen.

The screenshot shows the 'Alarm' screen with the 'Last' input set to '7 Days' and the date range '2013/11/22 - 2013/11/28'. The table below shows the alarm logs for this period.

First	Last	Error Code	Warning / Error
2013/11/28 14:04	2013/11/28 14:11		High Temp. ▲
2013/11/28 14:03	2013/11/28 14:03		Low Temp.
2013/11/28 12:17	2013/11/28 12:18		High Temp.
2013/11/28 12:14	2013/11/28 12:16		Low CO2 Density.
2013/11/28 12:15	2013/11/28 12:15	01	CO2 Gas Empty. ▼
2013/11/28 11:56	2013/11/28 12:14		High Temp. ▼

9 / 9

5. On the Alarm screen, by inputting days into the Last XX Days input box, alarm logs for specified days (containing that day) are displayed.

Settable range: 1 day~45 days.

Note: The error of about 1 minute may be observed during 1 month. Refer to page 52 for the procedure of setting time.

- Press Back key to return to the Log screen.
- Press Top key to return to the Top screen.

The screenshot shows the 'Alarm' screen with the 'Last' input set to '3 Days' and the date range '2013/11/26 - 2013/11/28'. The table below shows the alarm logs for this period.

First	Last	Error Code	Warning / Error
2013/11/28 14:11	2013/11/28 14:11		Low Temp.
2013/11/28 14:04	2013/11/28 14:11		High Temp.
2013/11/28 14:03	2013/11/28 14:03		Low Temp.
2013/11/28 12:17	2013/11/28 12:18		High Temp.
2013/11/28 12:14	2013/11/28 12:16		Low CO2 Density.
2013/11/28 12:15	2013/11/28 12:15	01	CO2 Gas Empty. ▼

9 / 9

● On the Alarm screen of procedure 4 or 5, alarm log data can be exported in CSV format to the USB memory inserted into the USB port.

6. Insert the USB memory into the USB port.

Note: It is not possible to use a USB memory with security functions that requires entering password.

7. Press Export key.

The screenshot shows the 'Alarm' screen with the 'Last' input set to '3 Days' and the date range '2013/11/26 - 2013/11/28'. The table below shows the alarm logs for this period.

First	Last	Error Code	Warning / Error
2013/11/28 14:11	2013/11/28 14:11		Low Temp.
2013/11/28 14:04	2013/11/28 14:11		High Temp.
2013/11/28 14:03	2013/11/28 14:03		Low Temp.
2013/11/28 12:17	2013/11/28 12:18		High Temp.
2013/11/28 12:14	2013/11/28 12:16		Low CO2 Density.
2013/11/28 12:15	2013/11/28 12:15	01	CO2 Gas Empty. ▼

9 / 9

8. When the export is complete, Information dialog box is displayed. Press OK key. Refer to page 50 and 51 for the details about abnormal export or exported file name.

The screenshot shows the 'Information' dialog box with the text 'Export complete.' and an 'OK' button. The background shows the 'Alarm' screen with the 'Last' input set to '3 Days' and the date range '2013/11/26 - 2013/11/28'. The table below shows the alarm logs for this period.

First	Last	Error Code	Warning / Error
2013/11/28 14:11	2013/11/28 14:11		Low Temp.
2013/11/28 14:04	2013/11/28 14:11		High Temp.
2013/11/28 14:03	2013/11/28 14:03		Low Temp.
2013/11/28 12:17	2013/11/28 12:18		High Temp.
2013/11/28 12:14	2013/11/28 12:16		Low CO2 Density.
2013/11/28 12:15	2013/11/28 12:15	01	CO2 Gas Empty. ▼

9 / 9

9. Press Top key to return to the Top screen.

Exporting alarm log

It is possible to export saved alarm log data to a USB memory inserted in the USB port by CSV format.

1. Insert a USB memory in the USB port.

Note: It is not possible to use a USB memory with security functions that requires entering password.

2. Press Menu key to lead the Menu screen.

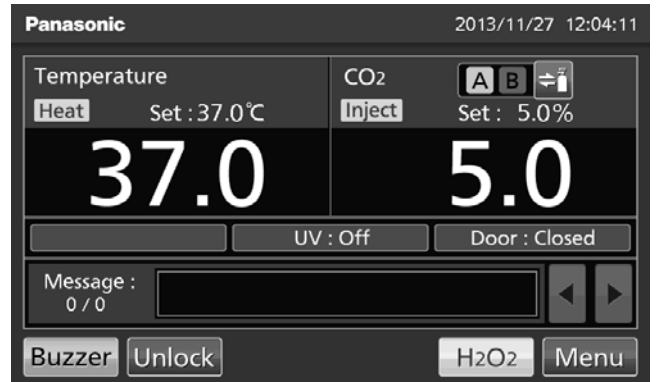

3. Press Log key to lead the Log screen.



4. Press Alarm Export key to lead Alarm Export screen.



OPERATION/ALARM LOG

5. On the Alarm Export screen, select the period to export.

·To export the saved alarm log data over the entire period, press All radio button.

·To export the alarm log data for the specified days (The newest period containing that day), press Last XX Days radio button and input days.
Settable range: 1 day~45 days.

Note: The error of about 1 minute may be observed during 1 month. Refer to page 52 for the procedure of setting time.

6. Press Export key.



Note:

·When USB memory is not inserted in the USB port, Notice dialog box is displayed. Press OK key and insert an USB memory into the USB port.

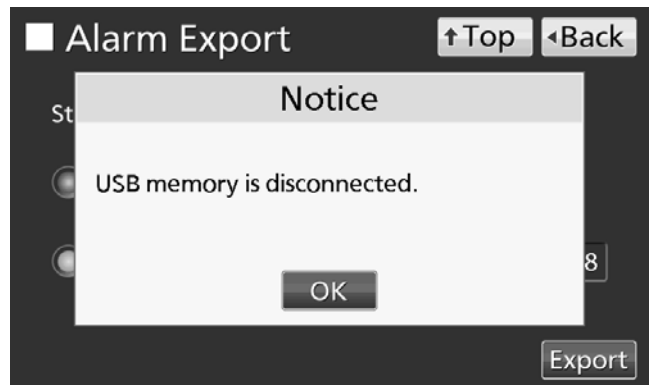

·When alarm log data doesn't exist in the specified days, Notice dialog box is displayed. Press OK key and specify days again as shown in the procedure 5.

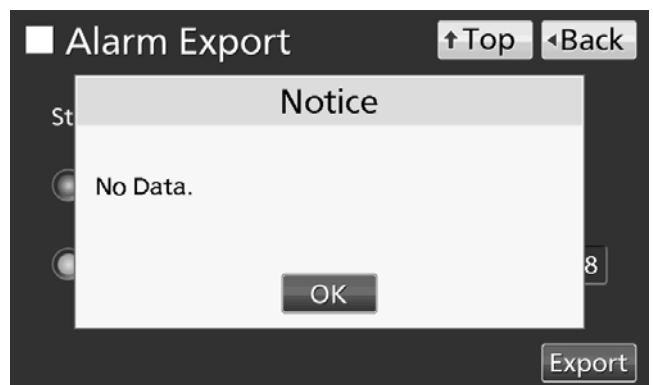

6. Even after completion the export of alarm log data, Information dialog box is displayed. Press OK key.

Note: After completing the export of alarm log data, alarm log data saved at CO₂ incubator is not deleted.

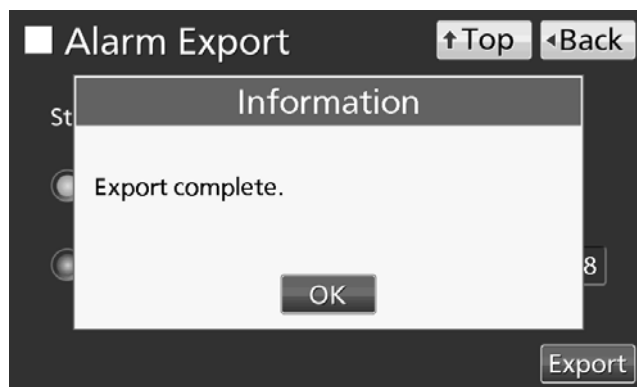

7. Remove a USB memory from the USB port.

Note: A log folder is created in a USB memory, and an exported data file is saved in the log folder by CSV format.

Exported file name; The first date during exported period (8 digits) + the last date (8 digits) + AlarmLog

Example) When exporting alarm log data for 7 days on January 7, 2014;

20140101-20140107_AlarmLog.csv

8. Press Top key to return to the Top screen.

OTHER PARAMETERS

Setting date and time

1. Press Menu key to lead the Menu screen.

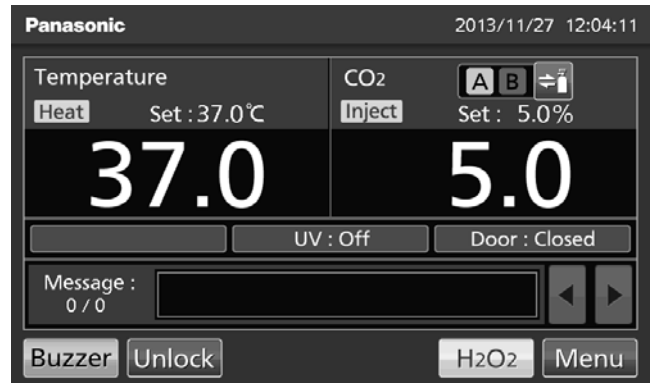

2. Press Tools #2 key to lead the Tools #2 screen.



3. Press Date & Time key to lead the Date & Time screen.



4. On the Date & Time screen, input the present date and time. Press Apply key to save the input value. The display returns to the Tools #2 screen.

Note:

- 24-hour clock.
- It is recommended to set the time periodically since the error of about 1 minute may be observed during a month.

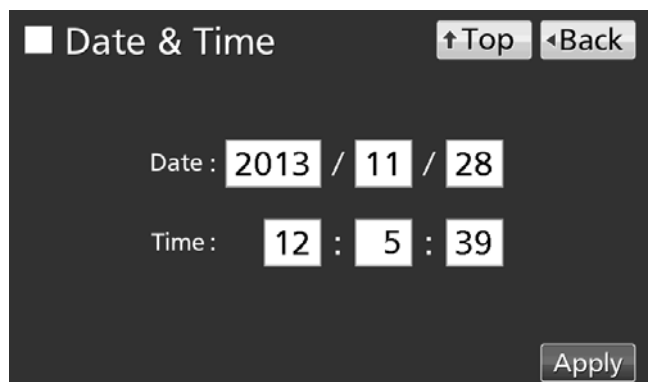

5. Press Top key to return to the Top screen.

Setting brightness and sleep

1. Press Menu key to lead the Menu screen.

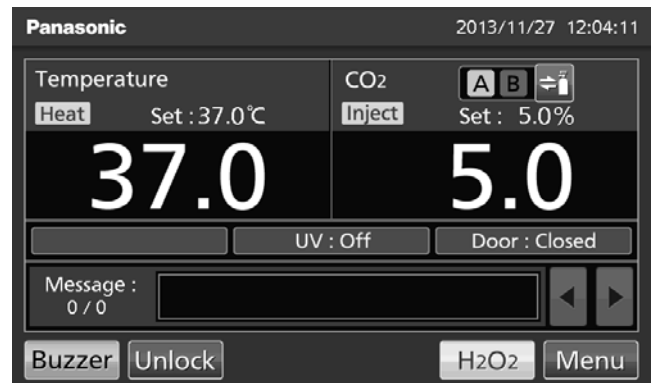

2. Press Tools #2 key to lead the Tools #2 screen.



3. Press Brightness/Sleep key to lead the Brightness/Sleep screen.



4. On the Brightness/Sleep screen, each setting of brightness and sleep is available. Press Apply key to save the input value and setup. The display returns to the Tools #2 screen.

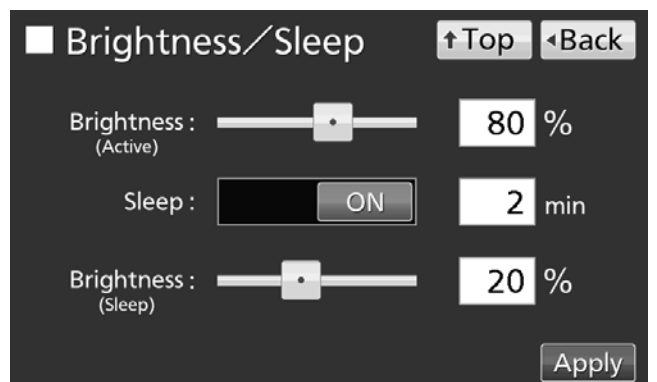

OTHER PARAMETERS

- Each setting

- Brightness(Active):

Brightness of LCD touch panel of the usual state. Adjust Brightness(Active) slide bar or input set value into the Brightness(Active) input box. Settable range: 50~100, factory setting: 80.

- Sleep:

The function is that the brightness of LCD touch panel is lowered to save electricity, when there is no key operation during set time.

By holding the Sleep slide key and sliding it right, the Sleep function is turned to ON. Input the set value of time to change the Sleep state. Settable range: 1 minute~5 minutes, factory setting: 2 minutes.

Note: It is not possible to operate any key in the Sleep state. By touching the LCD touch panel, the Sleep state is released and the LCD touch panel returns to the usual state. Under this condition, key operations are available.

- Brightness(Sleep):

Brightness of LCD touch panel of the Sleep state. Adjust Brightness(Sleep) slide bar or input set value into the Brightness(Sleep) input box. Settable range: 0~50, factory setting: 20.

5. Press Top key to return to the Top screen.

Setting DAQ

It is necessary to set several parameters when using our optional software product Data acquisition system (DAQ) MTR-5000.

1. Press Menu key to lead the Menu screen.

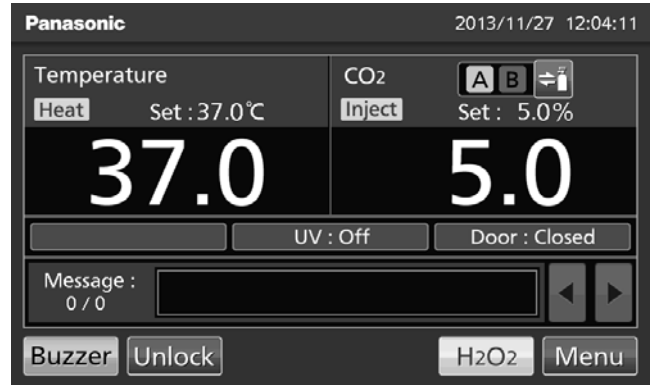

2. Press Tools #2 key to lead the Tools #2 screen.



3. Press DAQ Setting key to lead the DAQ Setting screen.



4. On the DAQ Setting screen, each setting of DAQ is available. Refer to the Procedure Setting Manual Data Acquisition System MTR-5000 for details of settings. Press Apply key to save the input value and setup. The display returns to the Tools #2 screen.

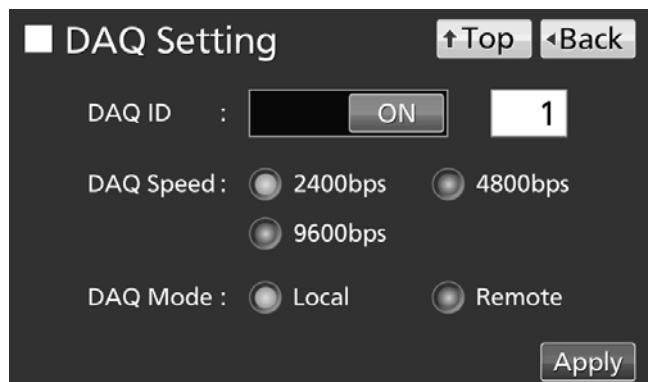

5. Press Top key to return to the Top screen.

UV LAMP PARAMETERS

MCO-170AICUVH/170AICUV or when an optional UV system set MCO-170UVS is installed to the MCO-170AIC, UV lamp is workable.

After closing the outer door, UV lamp lights for the preset period*, to disinfect the water in the humidifying pan, and the air circulating in the chamber.

Using UV lamp

1. Correctly install all of the inner attachments, and place the cultivation samples on the trays.

Note:

- The humidifying pan and humidifying pan cover prevent UV light from leaking. Always use them even when not humidifying.
- Never turn ON the UV lamp when the humidifying pan cover is removed.
- Always use the humidifying pan cover even when using the incubator without turning ON the UV lamp. Using without humidifying pan cover may have a bad influence on the chamber temperature distribution and humidity recovery.

2. When closing the outer door, the UV lamp lights for the preset period*.

Note:

- If the outer door is opened while the UV lamp is lit, the lamp will turn OFF. Then, when the door is closed, the lamp will light for the preset period*.
- If only the outer door is repeatedly opened and closed, it may have a bad influence on the condensation in the chamber and chamber temperature distribution because the UV lamp generates heat for a long time. It may also shorten the service life of the UV lamp.
- The preset period* can be changed when necessary as shown in the page 57~58.
- To check whether the UV lamp is lit, open the outer door and then press the door switch with the inner door close. Visible blue light can be confirmed from the front of the humidifying pan cover.

Note: UV light is harmful to the eyes, so do not light the UV lamp when the inner door is open.

WARNING

Do not look directly at UV light. UV light is harmful to the eyes.

3. If the outer door is not opened for at least 12 consecutive hours, the UV lamp lights for the preset period* every 12 hours.

Note: Outer door opening resets the 12-hours-count.

* The set period in UV Timer setting + the period extended by the UV Timer Ext.. Refer to page 58.

- The recommended replacement time for the UV lamp (i.e., when the UV output ratio drops to 60 % to 70 % of its initial value) is when the accumulated ON time reaches 5,000 hours. When the accumulated ON time reaches approximately 5,000 hours, "Warning: UV Bulb Life" is displayed in the message display field. It is recommended that the UV lamp be quickly replaced at this point. Contact our sales representative or agent for information on replacing the UV lamp.

- If the UV lamp burns out, “Err18: UV Lamp Abnormal” is displayed in the message display field. If this occurs, replace the UV lamp. When replacing the UV lamp, replace the glow starter (type FG-7P or FG-7PL) at the same time. Contact our sales representative or agent for information on replacing the UV lamp.

- If the UV lamp burns out (“Err18: UV Lamp Abnormal” is displayed in the message display field), it is not possible to perform H₂O₂ decontamination. Replace the UV lamp and the glow starter (type FG-7P or FG-7PL).

Setting UV lamp ON period

Use the following procedure to change the setting of the UV lamp ON period.

1. Press Menu key to lead the Menu screen.

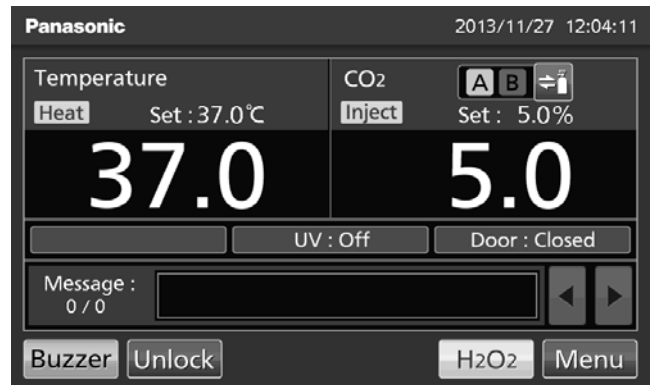

2. Press Tools #1 key to lead the Tools #1 screen.



3. Press UV Setting key to lead the UV Setting screen.



UV LAMP PARAMETERS

4. On the UV Setting screen, each setting of UV is available. Press Apply key to save the input value and setup. The display returns to the Tools #1 screen.

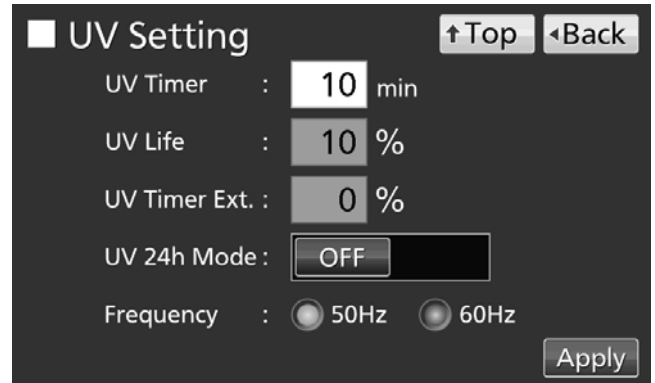

● Each setting

• UV Timer:

Set value of period to light UV lamp after closing the outer door.

Settable range: 0 minute~30 minutes, factory setting: 10 minutes.

Note:

• It is recommended to set the UV Timer for 10 minutes. The setting for less than 10 minutes may result in insufficient disinfection.

• When the UV timer is set for 0, the UV lamp does not light.

• UV Life:

The total time which UV lamp has turned on is displayed as the percentage to 5,000 hours which are recommendation time to replace. (It is impossible to set).

• UV Timer Ext.:

The more total time which UV lamp has turned on increases, the more UV ray output declines. In order to cover a decline of the UV ray output, the lighting time of UV lamp is automatically extended with an increase of total lighting time of UV lamp. (The set value of UV Timer is not changed).

Extension rate: 0 %~40 % (It is impossible to set), factory setting: 0 %.

Example) UV Timer: 10 minutes, UV Timer Ext.: 40 % → UV lamp lights for 14 minutes

• Frequency:

Frequency of a power supply. Press Frequency radio button of 50 Hz or 60 Hz. Factory setting: 50 Hz.

5. Press Top key to return to the Top screen.

Lighting UV lamp for 24 hours

If the chamber has been contaminated by dirt or by spilling the medium, use the following procedure to decontaminate the chamber by lighting the UV lamp for 24 hours.

1. Remove all attachments from the chamber, including the trays, the fan cover, the duct, the fan, the humidifying pan, and the humidifying pan cover. Clean all the attachments in an autoclave or with alcohol for disinfection.

2. Clean and wipe off inside the chamber with alcohol for disinfection.

3. Set the CO₂ density to 0 % and set the high limit alarm temperature to at least 10 °C higher than the chamber set temperature. Refer to page 32~33.

Note: The UV 24-hour mode may increase the chamber temperature.

4. Press Menu key to lead the Menu screen.

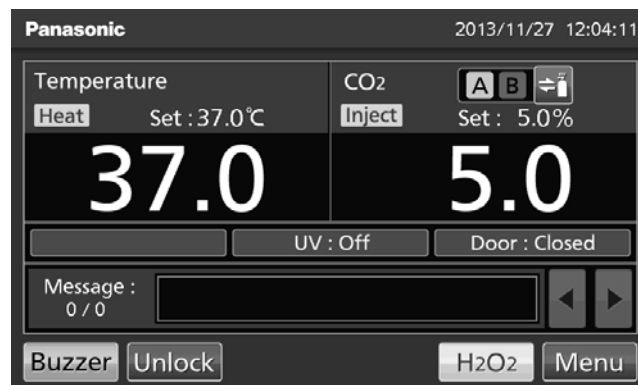

5. Press Tools #1 key to lead the Tools #1 screen.



6. Press UV Setting key to lead the UV Setting screen.

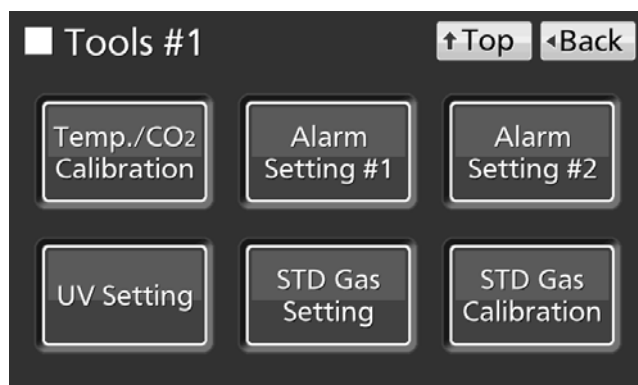

UV LAMP PARAMETERS

7. On the UV Setting screen, by holding the UV 24h Mode slide key and sliding it right, the UV 24h Mode is turned to ON. Press Apply key to start the UV 24-hour mode. The display returns to the Tools #1 screen.

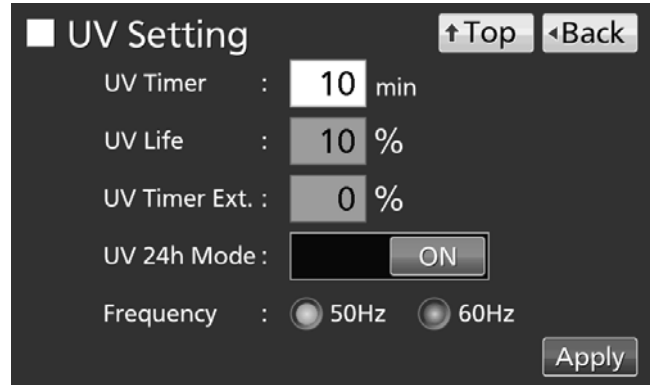

8. The UV lamp lights continuously for 24 hours. "UV : ON" is displayed on the UV lamp condition display when UV lamp is lighting.

Note:

- The UV 24-hour mode may cause the automatic set temperature alarm because of a rising chamber temperature.
- After procedure 8, by opening the outer door when UV lamp is lighting, UV lamp is turned OFF and UV 24-hour mode is canceled by opening the outer door. Redo from procedure 4 to start the UV 24-hour mode again.

9. Press Top key to return to the Top screen.

10. 24 hours after, UV lamp turns OFF automatically. Install all attachments removed in the procedure 1.

H₂O₂ DECONTAMINATION

When the chamber is contaminated or when cleaning the chamber prior to starting a culture, it is possible to perform H₂O₂ decontamination.

H₂O₂ decontamination function is workable under any of the following conditions. When the condition is not fulfilled, H₂O₂ decontamination can not be performed.

- When an H₂O₂ generator MCO-HP is installed in the MCO-170AICUVH.
- When all H₂O₂ generator MCO-HP, H₂O₂ decon board MCO-170HB and electric lock MCO-170EL are installed in the MCO-170AICUV
- When all UV system set MCO-170UVS, H₂O₂ generator MCO-HP, H₂O₂ decon board MCO-170HB and electric lock MCO-170EL are installed in the MCO-170AIC.

WARNING

Use the reagent specified by our company for H₂O₂ decontamination. Using a different H₂O₂ solution may cause explosion or damage to the incubator, or insufficient decontamination.

Do not use chemicals other than the H₂O₂ reagent, such as alcohol. Doing so may result in damage to the H₂O₂ vapor generator.

WARNING

When performing H₂O₂ decontamination, **make sure that the outer and inner doors are securely closed.** During H₂O₂ decontamination, plug the access hole with the silicon caps that are provided. Failure to do so may be harmful to health due to leakage of H₂O₂ gas.

WARNING

Never start H₂O₂ decontamination when “Warning: UV Bulb Life” is displayed in the message display field. The UV resolve is not sufficient.

CAUTION

H₂O₂ decontamination can be performed only for the chamber and inner attachments with standard specifications, and not for any other objects.

CAUTION

Perform H₂O₂ decontamination with the inner attachments arranged as specified by our company. Arranging them in a different way may result in insufficient decontamination.

CAUTION

Wear rubber gloves when handling the H₂O₂ reagent. Direct contact with the H₂O₂ reagent may result in inflammation of the skin.

CAUTION

After H₂O₂ decontamination has been completed, residual H₂O₂ solution will remain on the bottom of the chamber, the H₂O₂ vapor generator, and the bottom of the duct. **Wearing protective glasses and rubber gloves, wipe it off with a non-woven cloth.** Failure to do so may result in a deficient culture.

H₂O₂ DECONTAMINATION

H₂O₂ decontamination

1. Take out all the trays, the fan cover, the duct, the humidifying pan cover and the humidifying pan from the chamber.
2. Dispose of the water in the humidifying pan, and wipe inner attachments removed from the chamber, with a gauze containing water or alcohol for disinfection.
3. Wipe the inside walls of the chamber with a gauze containing water or alcohol for disinfection.
4. Attach the duct and the fan cover.

5. Pour one bottle of the H₂O₂ reagent MCO-H2O2 into the H₂O₂ generator MCO-HP (Fig. 1).

6. Set the two pins on the H₂O₂ generator in the 2 holes on the lower left side of the duct (Fig. 1).

Note: Make sure that the H₂O₂ generator is securely attached. Uncertain attachment may result in insufficient decontamination.

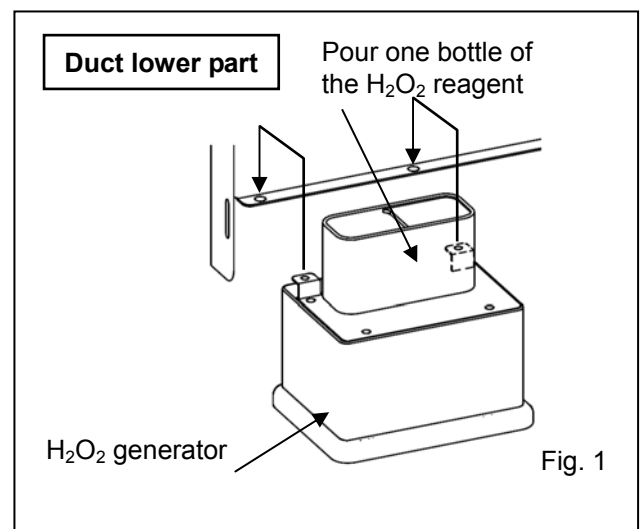

7. Remove a connector cap from connector on bottom right of the far side of the chamber. Connect the H₂O₂ generator and connector by a cable that is provided (Fig. 2).

Note: Be sure to keep the connector cap.

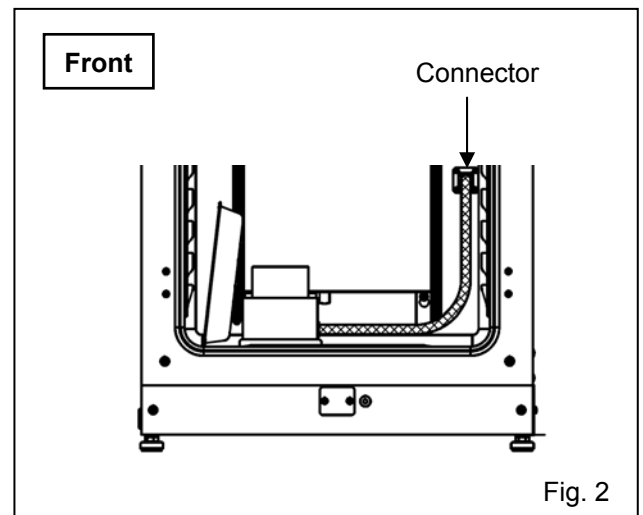

8. Insert 4 trays in the 2nd, the 3rd, the 4th and the 6th tray catches from the top of the chamber side.

Note: The trays included as accessory are designed to be appropriate for decontamination. If half tray (MCO-25ST, optional) or trays for previous models are used, decontamination may not be sufficiently effective.

9. Set the humidifying pan cover, the humidifying pan removed in the procedure 1 (Fig.3)

Note: H₂O₂ decontamination can be performed only for the chamber and inner attachments with standard specifications, not for any other objects.

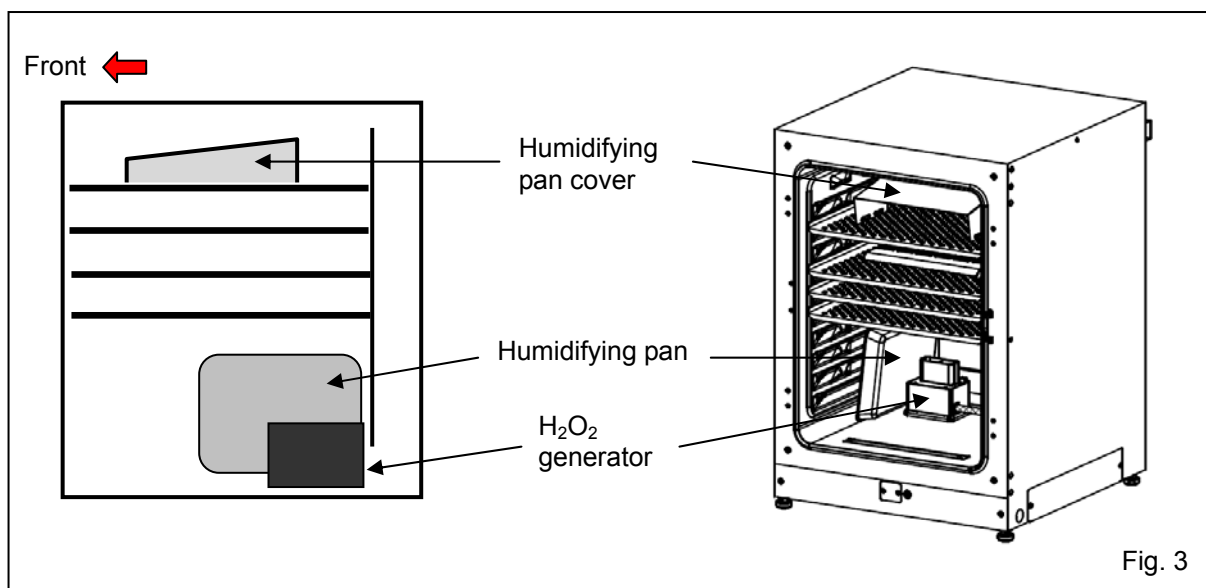

Fig. 3

10. Make sure that the duct, the fan and the H₂O₂ generator are securely attached (refer to Fig. 1 to 3 on page 83). After that, close the inner door and the outer door.

11. Press H₂O₂ key for 3 seconds to lead the H₂O₂ Decontamination screen.

Note:

- When the model does not have H₂O₂ decontamination function, H₂O₂ key is not displayed on the Top screen.
- When key lock is ON, Password input window is opened and input of the password is required. Refer to page 35.

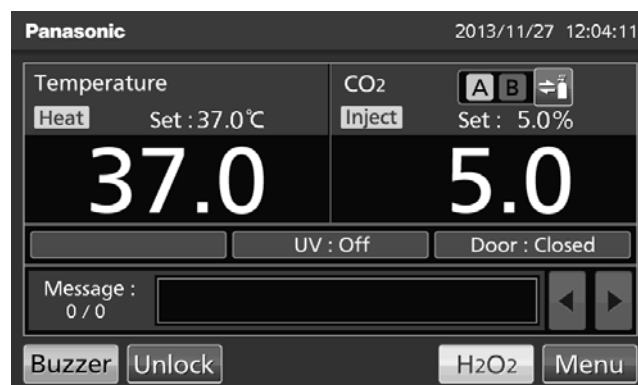

12. On the H₂O₂ Decontamination Step1 screen, the system check starts automatically. If the system is normal, the display leads the H₂O₂ Decontamination Step2 screen. When the system is abnormal, refer to Table 8 on page 80.

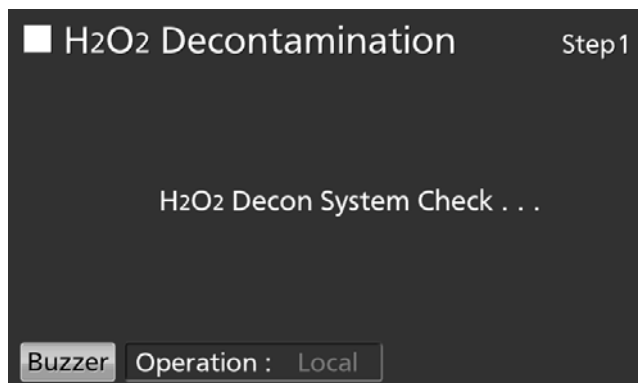

H₂O₂ DECONTAMINATION

13. On the H₂O₂ Decontamination Step2 screen, press OK key to lead the H₂O₂ Decontamination Step3 screen and H₂O₂ decontamination is started. H₂O₂ decontamination is performed automatically from Step3 to Step8 (procedure 14).

Note:

- The outer door is locked with electric lock for safety until completion of H₂O₂ decontamination.
- Buzzer sounds when H₂O₂ decontamination is completed (About 100 minutes later).

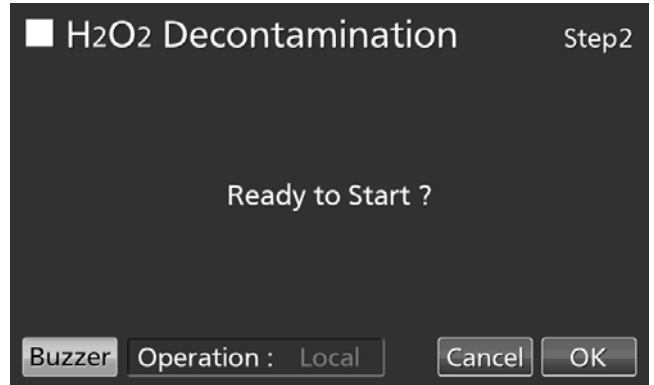

⚠ CAUTION

The electric lock will remain locked if power supply is cut off during H₂O₂ decontamination. After the power supply is recovers, the H₂O₂ gas resolution process will start execution and finish automatically. Execute the decontamination again because the decontamination is not completed.

⚠ WARNING

Do not use the unlock key to unlock the outer door during H₂O₂ decontamination or during H₂O₂ gas resolve by UV. Doing so may cause harm to health from H₂O₂ gas leakage.

● Step3 is the process to warm the chamber temperature to 45 °C.

Note: By pressing Abort key, H₂O₂ decontamination is stopped in the middle of decontamination and go to Step8 (The End of H₂O₂ decontamination).

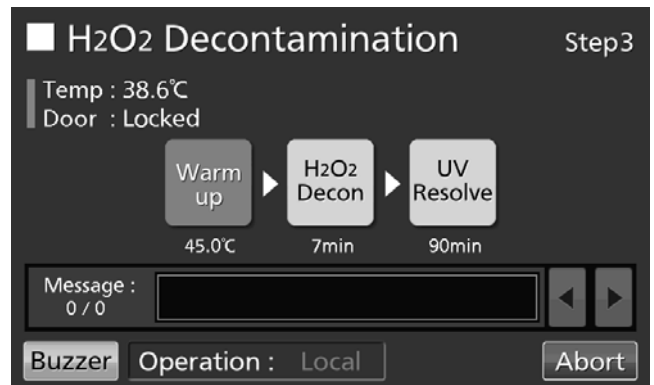

● Step4 is the process to decontaminate in the chamber by generating H₂O₂ vapor from H₂O₂ generator.

Note: By pressing Abort key, H₂O₂ decontamination is stopped in the middle of decontamination and go to Step7 (The process to resolve H₂O₂ vapor by UV lamp). It is not possible to skip Step7.

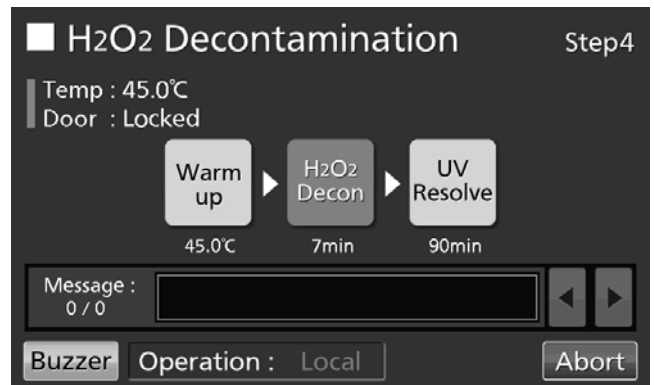

● Step7 is the process to resolve H₂O₂ vapor by UV lamp.

Note: Step5 and Step6 do not exist.

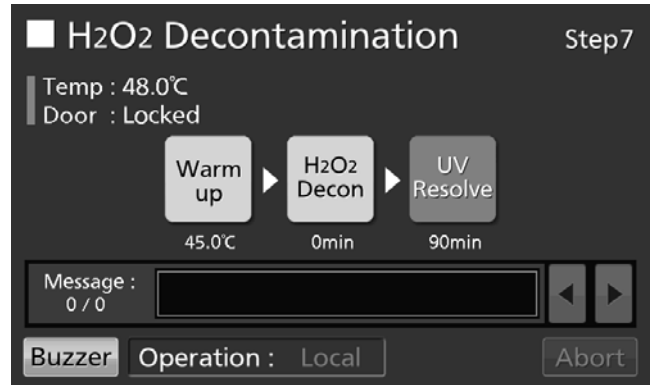

14. When the H₂O₂ decontamination is completed, the H₂O₂ Decontamination Step8 screen is displayed.

Open the outer and inner doors. Disconnect connector of the chamber, cable and H₂O₂ generator, and remove H₂O₂ generator and cable from the chamber.

Note: When doing the above work, put on protection glasses and rubber gloves.

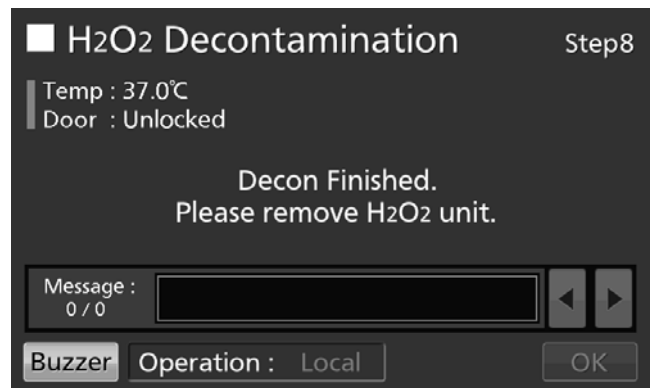

15. On the H₂O₂ Decontamination Step8 screen, press OK key to return to the Top screen.

Note: When H₂O₂ generator is connected with connector of the chamber by cable, OK key is not workable.

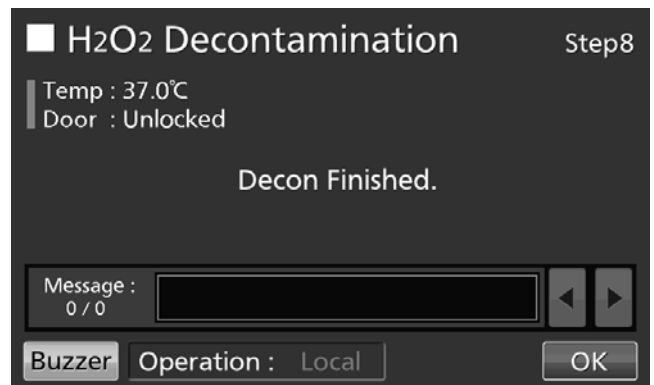

16. Dilute the remaining H₂O₂ reagent in the H₂O₂ generator with a large volume of water and dispose of it. Rinse and wash the H₂O₂ generator with distilled water. Then keep the H₂O₂ generator in a clean environment outside of the chamber.

Note: Do not wash either the inside or outside of the H₂O₂ generator with alcohol.

17. After H₂O₂ decontamination, surplus H₂O₂ liquid will remain at the bottom of the chamber and in the bottom part of the H₂O₂ generator duct. This solution contains H₂O₂ at a low density, so put on protective glasses and rubber gloves and wipe it up with a non-woven cloth.

18. Ventilate the chamber sufficiently and place all the attachments back into the chamber.

Note: After H₂O₂ decontamination, cover the connector on the chamber side with the connector cap deeply. (Fig. 4)

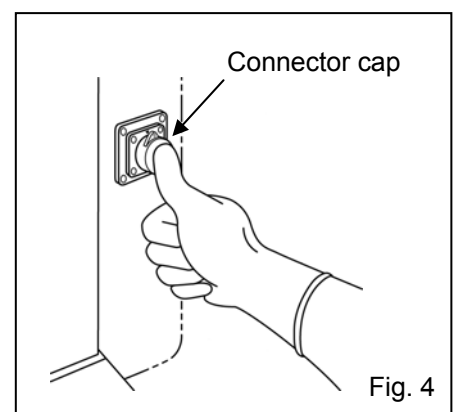

H₂O₂ DECONTAMINATION

Precautions when handling H₂O₂ reagent

Observe the following precautions when handling optional H₂O₂ reagent MCO-H2O2-PE.

- Handling precautions

- Wear protective equipment, such as protective glasses and rubber gloves.
- Do not use fire in the area where the reagent is being handled.
- Do not leave any reagent in the container after it has been used or while it is being used.
- Do not place inflammable or combustible materials near the area where the reagent is handled.

- Precautions for storage

- Store in a cool, dark place.
- Always close the container cover securely to prevent impurities from becoming mixed in the reagent.
- Check the container to make sure that there is no damage, corrosion, or cracking.
- Store the container with the inlet facing upwards, and make sure that the container will not tip or be knocked over.

- Precautions for disposal

- Dispose according to the rule in your country.

Using unlock key

- **Unlocking when power is interrupted**

MCO-170AICUVH or when an optional electric lock MCO-170EL is installed to the MCO-170AICUV/170AIC, outer door is locked with electric lock under a power outage. To unlock the outer door while the power is interrupted, use the unlock key that is provided. To re-lock the outer door, turn the unlock key to the lock direction while the outer door is open. After the outer door has been locked condition manually, then close the outer door.

Note: The outer door cannot be locked by using the unlock key while the outer door is closed. Lock the outer door while it is open. Attempting to turn the unlock key while the outer door is closed may damage the electric lock system.

WARNING

Do not use the unlock key to unlock the outer door during H₂O₂ decontamination or during H₂O₂ gas resolve by UV. Doing so may cause harm to health from H₂O₂ gas leakage.

ELECTRIC LOCK (OPTION)

MCO-170AICUVH or when an optional electric lock MCO-170EL is installed to the MCO-170AICUV/170AIC, auto lock function by electric lock is available.

Setting auto lock

1. Press Menu key to lead the Menu screen.

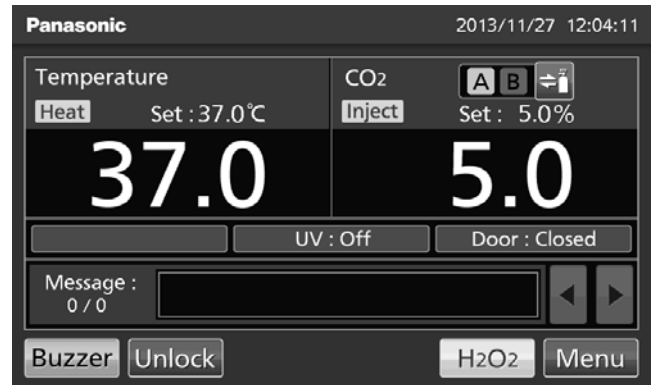

2. Press Set key to lead the Stand-by Setting screen.



3. On the Stand-by Setting screen, auto lock setting is available. Press Apply key to turn the auto lock ON and save the set value. The display returns to the Menu screen.

● Each setting of auto lock

Auto lock function is that the outer door is locked automatically when the setting time passed after the door closed. By holding the Auto-lock slide key and sliding it right, the Auto-lock is turned to ON. Settable range: 1 minute~60 minutes

Factory setting: 1 minute.

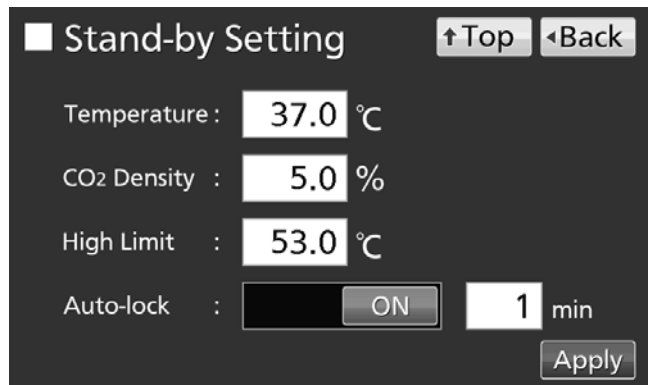

4. Press Back key to return to the Top screen.

ELECTRIC LOCK (OPTION)

● Press the Unlock key on the Top screen to unlock the outer door .

Note:

- When key lock is ON, Password input window is displayed to input the password. Refer to page 35.
- When the unlocked outer door is closed and the setting time passes, the unlocked outer door is re-locked automatically.

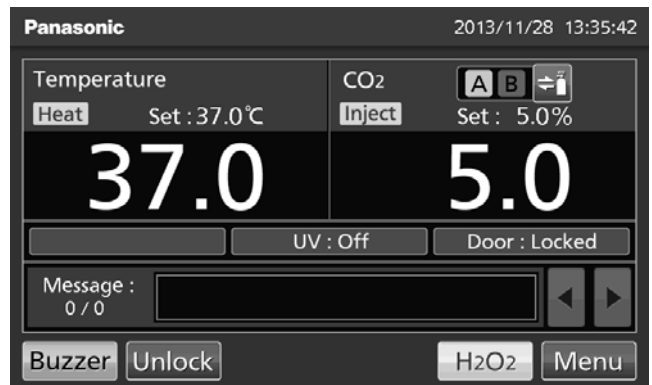

Using unlock key

● **Unlocking when power is interrupted**

MCO-170AICUVH or when an optional electric lock MCO-170EL is installed to the MCO-170AICUVH/170AIC, outer door is locked with electric lock under a power outage. To unlock the outer door while the power is interrupted, use the unlock key that is provided. To re-lock the outer door, turn the unlock key to the lock direction while the outer door is open. Close the outer door after the outer door is locked manually.

Note: The outer door cannot be locked by using the unlock key while the outer door is closed. Lock the outer door while it is open. Attempting to turn the unlock key while the outer door is closed may damage the electric lock system.

Removing auto lock

1. Press Menu key to lead the Menu screen.

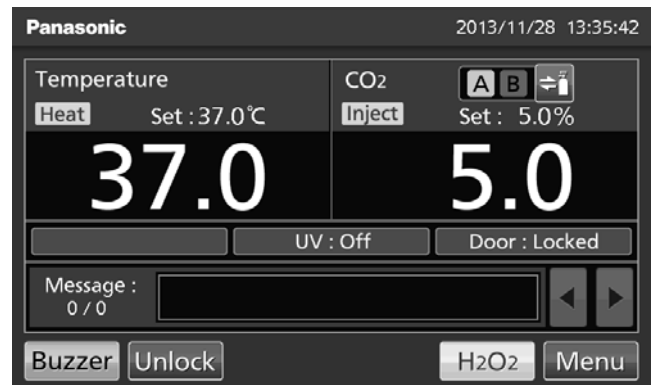

2. Press Set key to lead the Stand-by Setting screen.



3. On the Stand-by Setting screen, by holding the Auto-lock slide key and sliding it left, the Auto-lock is turned to OFF. Press Apply key to change Auto-lock OFF, and the display returns to the Menu screen.

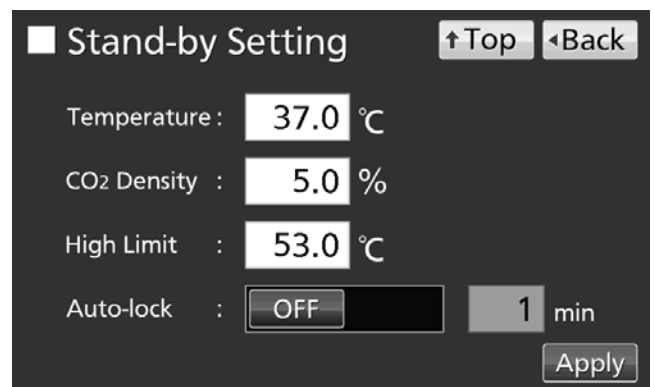

4. Press Back key to return to the Top screen.

GAS AUTO CHANGER (OPTION)

When an optional gas auto changer MCO-21GC is installed, there are two connecting ports for CO₂ gas pipe, A and B. By connecting two CO₂ gas cylinders, this kit switches the CO₂ gas supply line when one of the CO₂ gas cylinders becomes empty.

Connecting CO₂ gas cylinder

1. Get two CO₂ gas cylinder ready (CO₂ gas cylinder A and B) and install an optional gas regulator MCO-100L-PW in both of CO₂ gas cylinders.

Note:

- Use a liquefied CO₂ gas cylinder (at least 99.5 % pure). The siphon (dip tube) type cannot be used.
- When MCO-100L-PW is not available, install a gas regulator rated at 25 MPa(G) (250 kgf/cm²(G), 3600 psi(G)) for the primary side, and 0.2 MPa(G) (2 kgf/cm²(G), 30 psi(G)) for the secondary side.

2. Using a gas tube that is provided, connect the connecting port A for CO₂ gas pipe and the gas regulator of the CO₂ gas cylinder A.

3. Using a gas tube that is provided, connect the connecting port B for CO₂ gas pipe and the gas regulator of the CO₂ gas cylinder B.

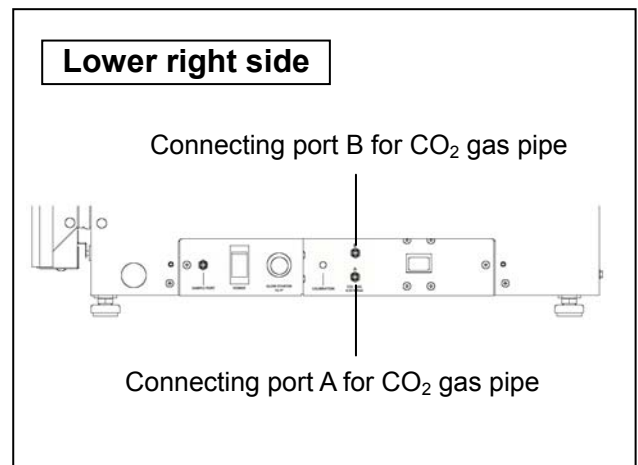

Note: If the CO₂ gas is supplied to multiple CO₂ incubators from a single gas cylinder, a CO₂ solid will be formed in the gas regulator. The gas regulator safety valve will operate, and it may make an explosive sound.

4. After connecting the gas tube, make sure that no gas is leaking.

5. Both CO₂ gas cylinder A and B, set the CO₂ gas on the secondary side to 0.03 MPa(G) (0.3 kgf/cm²(G), 4.3 psi(G)) for gas injection.

Note: As the pressure increases, the CO₂ gas density control range will increase. Excessive pressure may cause gas supply lines inside the incubator to come loose, which may result in gas poisoning or oxygen deprivation due to the escaping of gas. If gas lines come loose, the incubator must be repaired.

Automatic CO₂ gas supply line changeover

When an optional gas auto changer MCO-21GC is installed, CO₂ gas supply line indicator A·B and CO₂ gas supply line select key are displayed in the Top screen. CO₂ gas supply line indicator A or B being used is lighted.

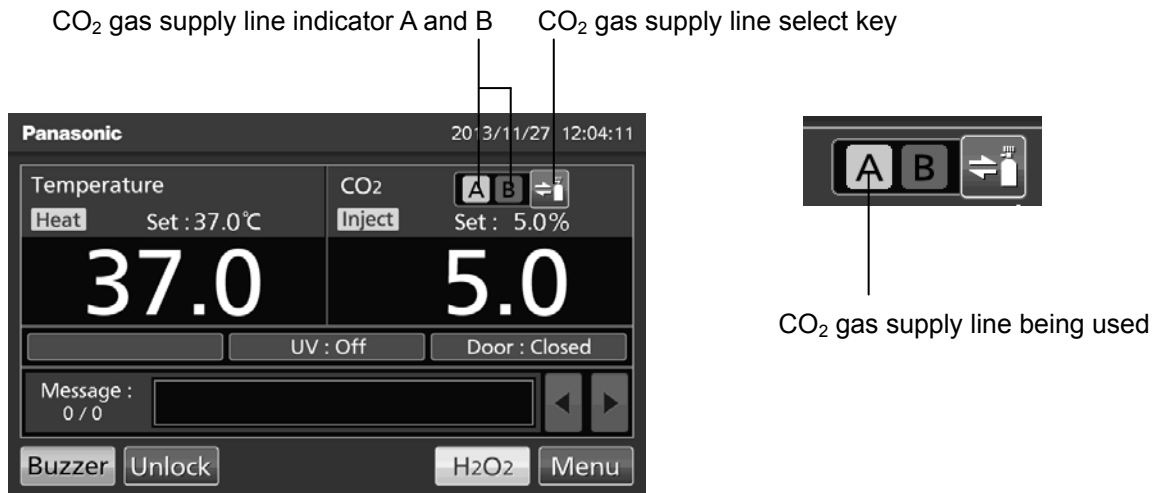





GAS AUTO CHANGER (OPTION)

When the CO₂ density level remains unchanged, even though the CO₂ gas valve in the unit is opened, the unit regards the present connecting CO₂ gas cylinder as an empty. The CO₂ gas supply line is changed over automatically. These movements are displayed (Table. 2).

1. When CO₂ gas is remaining in CO₂ gas cylinder A, the unit operates with CO₂ gas supplied from CO₂ gas cylinder A (Situation 1 on table 2).
2. When CO₂ gas cylinder A is empty, the level of CO₂ density in the unit does not increase because CO₂ gas is not supplied into the unit even though CO₂ gas valve in the unit is open (Situation 2 on table 2).
3. When the Situation 2 continues for 2 to 3 minutes, CO₂ gas supply line is changed over automatically by regarding CO₂ gas cylinder as an empty. At this time, CO₂ gas empty alarm is activated, the buzzer sounds, and CO₂ gas supply indicator A is displayed in reverse video and blinks (Situation 3 on table 2).
4. CO₂ gas empty alarm is released by pressing Buzzer key. The reverse video is put the light off (Situation 4 on table 2).
5. Exchange the empty CO₂ gas cylinder A into a new one immediately after the Situation 4 (Situation 5 on table 2).
6. When CO₂ gas cylinder B is empty, it changes into CO₂ gas cylinder A.

Table 2 CO₂ gas supply line automatic changeover

(e.g.) When CO₂ gas cylinder A is empty, it changes over CO₂ gas cylinder B.

Situation	CO ₂ gas			CO ₂ gas supply line indicator			Message display field
	Supply line	Cylinder A	Cylinder B		A	B	
1 CO ₂ gas is supplying from valve A	A	Remaining	Remaining		Light on	Light off	
2 CO ₂ density in the chamber is not increased even if CO ₂ gas valve opens	A	Empty	Remaining		Light on	Light off	
3 CO ₂ gas supply line is changed over B automatically	B	Empty	Remaining		Reverse video and blink	Light on	Err01: CO ₂ Gas Empty (and buzzer)
4 Pressed Buzzer key	B	Empty	Remaining		Light off	Light on	
5 Changed empty gas cylinder A into a new one	B	Remaining	Remaining		Light off	Light on	

Note:

- When the Buzzer key is not pressed in the Situation 4 and the CO₂ gas cylinder B gets empty without the CO₂ gas cylinder A being replaced in the Situation 5, the operation of switch between CO₂ gas supply line A and B will be repeated. In this case, replace the both CO₂ gas cylinders, A and B, and press the Buzzer key immediately.
- The changeover of CO₂ gas cylinder is judged by an increase of CO₂ density in the chamber. In case that the gas tube is clogged, the gas is leaking, the gas pressure is dropped down, or the level of valve open for CO₂ gas cylinder is not enough, etc, the changeover of CO₂ gas cylinder may be done even though the CO₂ gas cylinder being used is not empty.

Manual CO₂ gas supply line changeover

It is possible to change CO₂ gas supply line manually anytime.

Example) Change CO₂ gas supply line A to B.

1. Press CO₂ gas supply line select key for a few seconds.

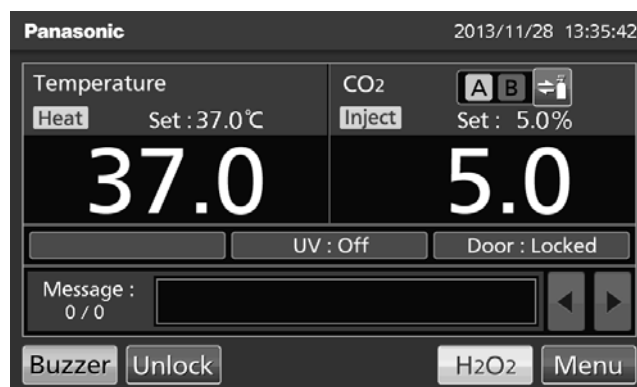

2. CO₂ gas supply line A is changed to B.

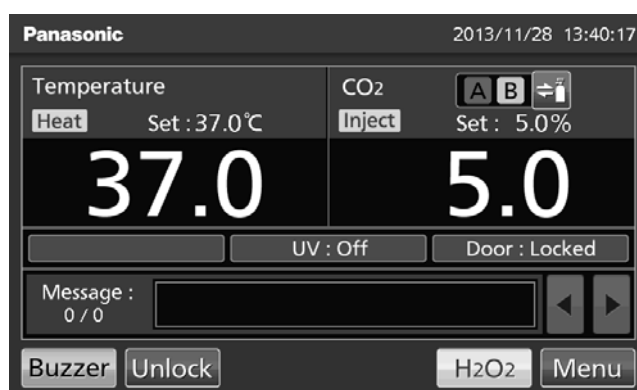

Note: The behavior for the following case is shown in Table 3.

After the CO₂ gas supply line is changed over by CO₂ gas automatic changer function, the empty CO₂ gas is manually returned to the CO₂ gas supply line before the Buzzer key is pressed.

Table 3 After changed into CO₂ gas cylinder B because CO₂ gas cylinder A is empty, if you changed into A manually.

	Situation	CO ₂ gas			CO ₂ gas supply line indicator			Message display field
		Supply line	Cylinder A	Cylinder B		A	B	
1	Changed into CO ₂ gas supply line B automatically	B	Empty	Remaining		Reverse video and blink	Light on	Err01: CO ₂ Gas Empty (and buzzer)
2	Not press Buzzer key, long-pressed CO ₂ gas supply line select key	A	Empty	Remaining		Blink	Light off	Err01: CO ₂ Gas Empty (and buzzer)

STD GAS AUTO CALIBRATION KIT (OPTION)

When a STD gas auto calibration kit MCO-SG is installed, by connecting standard gas cylinder for calibration, it is possible to calibrate CO₂ density manually.

1. Connect a standard gas cylinder to connecting port for standard gas cylinder on lower right side of the CO₂ incubator. Since a Standard gas cylinder is used as a standard of exact density during CO₂ density calibration, prepare a standard gas cylinder that is same as the set CO₂ density.

Note: There is not the problem to remain connected standard gas cylinder after finished CO₂ gas density calibration.

2. Press Menu key to lead the Menu screen.

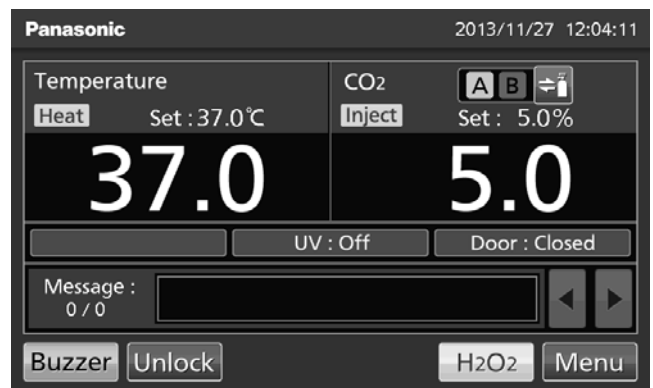
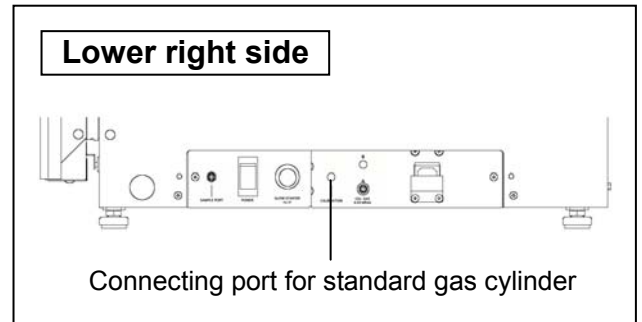

3. Press Tools #1 key to lead the Tools #1 screen.



4. Press STD Gas Setting key to lead the STD Gas Setting screen.



5. On the STD Gas Setting screen, input CO₂ density of the connected standard CO₂ gas cylinder. Press Apply key to save the input value. The display returns to the Tools #1 screen.

Settable range: 4.0 %~21.0 %

Factory setting: 5.0 %

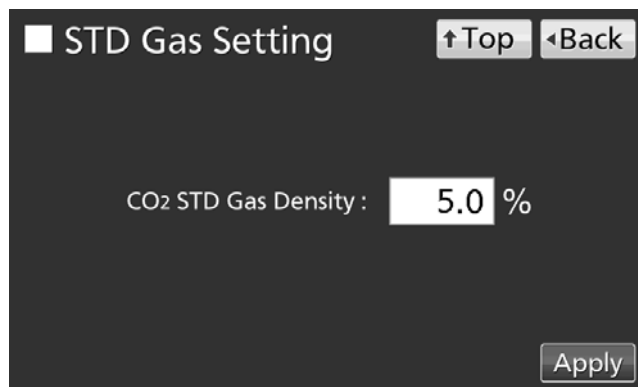

6. Press STD Gas Calibration key to lead the STD Gas Calibration screen.



7. On the STD Gas Calibration Step1 screen, system check starts automatically. If the system is normal, display leads the STD Gas Calibration Step2 screen.

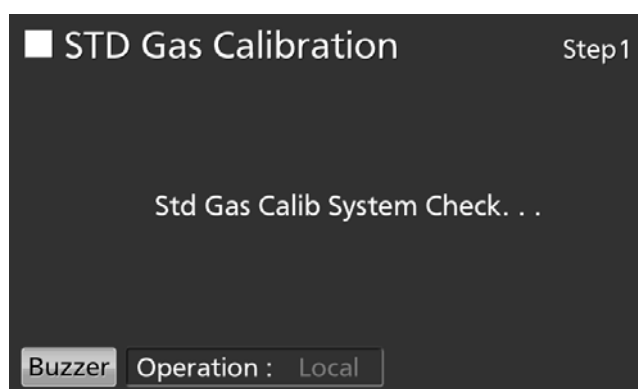

8. On the STD Gas Calibration Step2 screen, press OK key to lead the STD Gas Calibration Step3 screen.

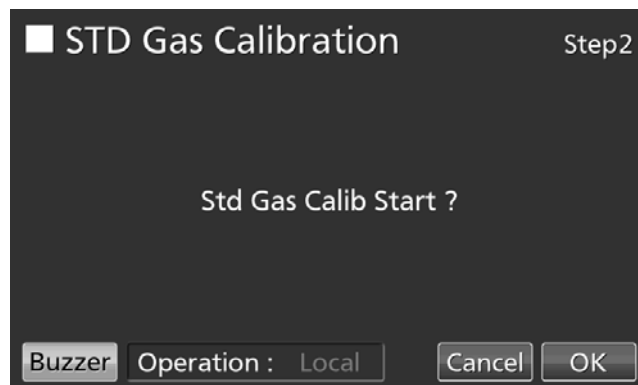

STD GAS AUTO CALIBRATION KIT (OPTION)

9. On the STD Gas Calibration Step3 screen, CO₂ density calibration starts. Calibration go to Step5 (Procedure 10) automatically.

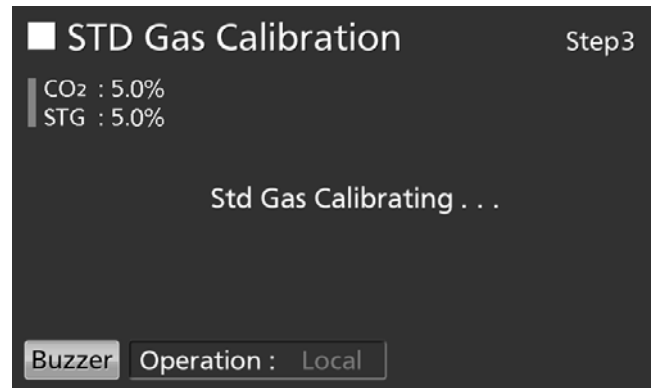

10. After completion of CO₂ density calibration, display leads the STD Gas Calibration Step5 screen. CO₂ incubator returns to the normal operation.

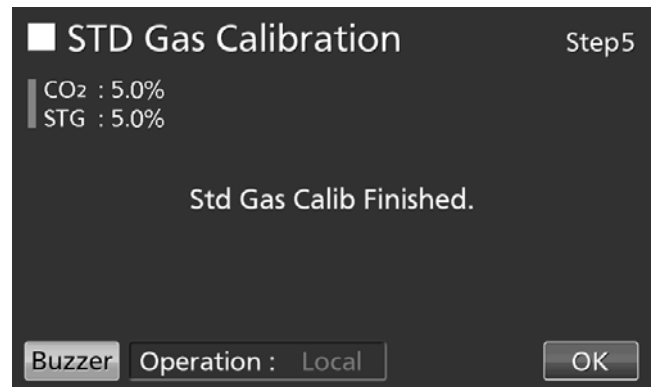

11. On the STD Gas Calibration Step5 screen, press OK key to return to the Tools #1 screen. On the Tools #1 screen, press Top key to return to the Top screen.

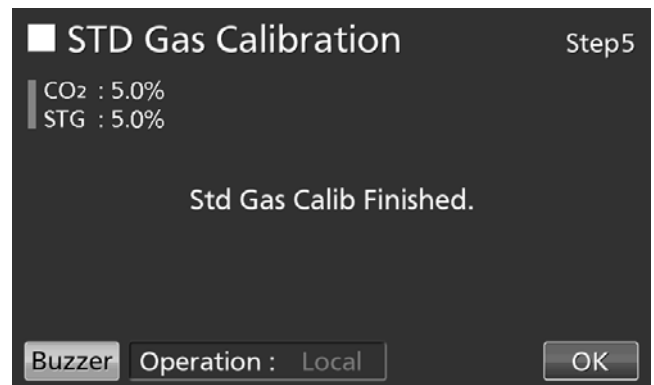

ROUTINE MAINTENANCE

To use this unit in a clean condition, clean the chamber and all the inner attachments at least once a month.

1. Remove all the inner attachments by the procedures shown on page 22.
 2. Clean the chamber and all the inner attachments by the procedures shown on page 21.
 3. Install all the inner attachments by the procedures shown on page 24.
- When there is excessive dirt, contact our sales representative or agent.

ALARMS, SAFETY, AND SELF-DIAGNOSIS

The incubator supports the following alarms, safety functions, and self-diagnostic functions. If an error from Err05 to Err18, or Err56 is activated, contact our sales representative or agent.

Table 4 Alarms, safety, and self-diagnosis for culture operations

Alarm or safety function	Conditions	Display	Buzzer	Remote alarm	Safety operation
High limit temperature alarm	The chamber temperature exceeds the high limit alarm temperature set value.	"Over Heat" is displayed alternately in normal characters and reverse video in the Over heat display.	Continuous tone	ON	Heater OFF.
Automatic set temperature alarm	The chamber temperature is out of the automatic set temperature alarm setting range ($\pm 1.0\text{ }^{\circ}\text{C}$ to $\pm 5.0\text{ }^{\circ}\text{C}$).	"Warning :High Temp" or "Warning :Low Temp" is displayed in the message display field.	Intermittent tone after set alarm delay time (0 min to 15 min) has elapsed	ON after set alarm delay time (0 min to 15 min) has elapsed	-----
Automatic set CO ₂ density alarm	The chamber CO ₂ density is out of the automatic set CO ₂ density alarm setting range ($\pm 0.5\%$ to $\pm 5.0\%$).	"Warning :High CO ₂ Density" or "Warning :Low CO ₂ Density" is displayed in the message display field.	Intermittent tone after set alarm delay time (0 min to 15 min) has elapsed	ON after set alarm delay time (0 min to 15 min) has elapsed	-----
Auto-return	On screens other than the Top screen, there is no key operation for approx. 90 s. (When the sleep function is ON) After sleep function is turned ON, there is no alarm/error and key operation for approx. 90 s.	(Return to the "Top screen".)	-----	-----	-----
Door alarm	The outer door is open.	"Door : Open" is displayed alternately in normal characters and reverse video in the outer door (opening/closing) display.	Intermittent tone after set alarm delay time (1 min to 30 min) has elapsed	-----	The CO ₂ valve is closed. The heater turns OFF after 1 min.
Door lock error	(MCO-170AICUVH or when an optional MCO-170EL is installed) Outer door is opened when it is auto-locked by electric lock.	"Err20: Door Lock Failure" is displayed in the message display field.	Intermittent tone	ON	UV lamp OFF
CO ₂ gas cylinder empty	The CO ₂ density does not increase when the CO ₂ valve is opened.	"Err01: CO ₂ Gas Empty" is displayed in the message display field.	" "	" "	-----
Chamber temperature sensor error	The chamber temperature sensor is disconnected.	"Err05: Temp Sensor Open" is displayed in the message display field.	" "	" "	Heater OFF.
	The chamber temperature sensor is short-circuited.	"Err06: Temp Sensor Short" is displayed in the message display field.	" "	" "	Heater OFF.
Sensor box temperature sensor error	The sensor box temperature sensor is disconnected.	"Err07: CO ₂ Box Temp Sensor Open" is displayed in the message display field.	" "	" "	CO ₂ valve is closed.
	The sensor box temperature sensor is short-circuited.	"Err08: CO ₂ Box Temp Sensor Short" is displayed in the message display field.	" "	" "	CO ₂ valve is closed.
Ambient temperature sensor error	The ambient temperature sensor is disconnected.	"Err09: AT Sensor Open" is displayed in the message display field.	" "	" "	-----
	The ambient temperature sensor is short-circuited.	"Err10: AT Sensor Short" is displayed in the message display field.	" "	" "	-----
CO ₂ sensor error	The Vref or Vgas output voltage for the CO ₂ sensor is abnormal.	"Err11: CO ₂ Sensor Vref Abnormal" or "Err12: CO ₂ Sensor Gas Abnormal" is displayed in the message display field.	" "	" "	CO ₂ valve is closed.
Main heater error	Main heater burnout occurs or the main heater SSR is short-circuited	"Err13: Main Heater Abnormal" is displayed in the message display field.	" "	" "	-----
Bottom heater error	Bottom heater burnout occurs or the bottom heater SSR is short-circuited.	"Err14: Humidity Heater Abnormal" is displayed in the message display field.	" "	" "	-----
Door heater error	Door heater burnout occurs or the door heater SSR is short-circuited.	"Err15: Door Heater Abnormal" is displayed in the message display field.	" "	" "	-----
Sensor box heater error* ¹	a) High limit temperature alarm is activated. b) The sensor box heater burnout occurs or the sensor box heater SSR is short-circuited.	"Err16: CO ₂ Box Heater Abnormal" is displayed in the message display field.	" "	" "	-----
Heater SSR burnout* ¹	a) High limit temperature alarm is activated. b) Main, bottom, door, or sensor box heater SSR burnout occurs.	"Err17: Heater SSR Open" is displayed in the message display field.	" "	" "	-----

*1: After a while after the high limit temperature alarm is activated, Err16 (Sensor box heater error) and Err17 (Heater SSR burnout) are activated.

Alarm or safety function	Conditions	Display	Buzzer	Remote alarm	Safety operation
UV lamp failure	(MCO-170AICUVH/MCO-170AICUV, or when an optional MCO-170UVS is installed) The UV lamp burns out	"Err18: UV Lamp Abnormal" is displayed in the message display field.	Intermittent tone	ON	----
New UV lamp replacement	(MCO-170AICUVH/MCO-170AICUV, or when an optional MCO-170UVS is installed) The accumulated ON time reaches approx. 5,000 h	"Warning: UV Bulb Life" is displayed in the message display field.	----	----	----
Communication error	When communication between LCD touch panel and control substrate is died out or unstable.	"Err56: Communication Failure" is displayed in the message display field.	----	----	----

● Table 5~7 show the behavior of the alarm (buzzer) and Ring Back function when pressing Buzzer key.

Table 5 In the cases of other than table 6 or table 7.

Remote Alarm setting	Ring Back setting	Buzzer from CO ₂ incubator		Remote Alarm	
		When pressing the Buzzer key	When the Ring Back set time passes	When pressing the Buzzer key	When the Ring Back set time passes
ON: Non-interlock with Buzzer key	ON	OFF (Alarm is not canceled)	ON	ON	ON (Under continuation)
	OFF		OFF		
OFF: Interlock with Buzzer key	ON		ON	OFF (Alarm is not canceled)	ON
	OFF		OFF		OFF

Note: Resolve the cause of the alarm in reference to page 78-80 because the alarm itself is not deactivated by pressing Buzzer key

Table 6 In the cases of high limit temperature alarm or Err38 (The outer door opens during H₂O₂ decontamination; refer to next page)

Remote Alarm setting	Ring Back setting	Buzzer from CO ₂ incubator		Remote Alarm	
		When pressing the Buzzer key	When the Ring Back set time passes	When pressing the Buzzer key	When the Ring Back set time passes
ON: Non-interlock with Buzzer key	ON	ON	ON (Under continuation)	ON	ON (Under continuation)
	OFF				
OFF: Interlock with Buzzer key	ON			(Continue)	
	OFF				

Note: Close the outer door when Err38 is activated.

Table 7 In the cases of Err01 (CO₂ gas cylinder empty), Err11, 12 (CO₂ sensor error), Err18 (UV lamp failure) or door alarm*.

Remote Alarm setting	Ring Back setting	Buzzer from CO ₂ incubator		Remote Alarm setting	
		When pressing the Buzzer key	When the Ring Back set time passes	When pressing the Buzzer key	When the Ring Back set time passes
ON: Non-interlock with Buzzer key	ON	OFF (Alarm is canceled)	OFF (Alarm is already canceled)	OFF (Alarm is canceled* ²)	OFF (Alarm is already canceled* ²)
	OFF				
OFF: Interlock with Buzzer key	ON			OFF	
	OFF				

*2: In the door alarm, the remote alarm does not work.

Note: Err01 recovery is achieved automatically by correctly connecting the new CO₂ gas cylinder and pressing the Buzzer key to stop the buzzer. In addition, when the optional MCO-21GC is installed and the gas supply is switched to the reserve gas cylinder, press the Buzzer key and replace the gas cylinder.

ALARMS, SAFETY, AND SELF-DIAGNOSIS

Table 8 Alarms and Safety functions for H₂O₂ decontamination

Alarm or safety function	Conditions	Display	Buzzer	Remote alarm	Safety operation
System check error at start of H ₂ O ₂ decontamination	The H ₂ O ₂ generator is not connected.	"Err31:H2O2 Unit Not Connect" is displayed in the message display field.	----	----	H ₂ O ₂ decontamination is cancelled.
	There is no H ₂ O ₂ solution or the H ₂ O ₂ level sensor has failed (or is disconnected).	"Err32: Low H2O2 Level" is displayed in the message display field.	----	----	H ₂ O ₂ decontamination is cancelled.
	The door is not closed.	"Err33: Outer Door Open" is displayed in the message display field.	----	----	H ₂ O ₂ decontamination is cancelled.
Failure during warming-up	Power was interrupted.	After power is restored, return to the "Top Display".	----	----	----
	The outer door is open.	"Err38:Door Lock Failure" is displayed in the message display field.	Continuous tone (when the outer door is open.)	ON (when the outer door is open.)	H ₂ O ₂ decontamination is cancelled.
Failure during H ₂ O ₂ decontamination	The volume of H ₂ O ₂ generated is abnormal.	"Err34:H2O2 Volume" is displayed in the message display field.	Intermittent tone with 15min delay	ON with 15 min delay	Moves to UV resolve.
	Power was interrupted during H ₂ O ₂ decontamination.	After power is restored, "Err35: Power Failure" is displayed in the message display field.	Intermittent tone	ON	• During power failure, outer door is locked by electric lock. • After power is restored, moves to UV resolve.
	The outer door is open.	"Err38:Door Lock Failure" is displayed in the message display field.	Continuous tone (when the outer door is open.)	ON (when the outer door is open.)	• H ₂ O ₂ mist generation is cancelled. • Resolve time is extended.
Failure during H ₂ O ₂ gas resolve by UV.	The UV lamp failed during H ₂ O ₂ gas resolve by UV.	"Err36: UV Lamp Failure" is displayed in the message display field.	Intermittent tone	ON	Resolve time is extended.
	Power was interrupted during H ₂ O ₂ gas resolve by UV.	After power is restored, "Err37: Power Failure" is displayed in the message display field.	----	----	• During power failure, outer door is locked by electric lock. • After power is restored, UV resolve is repeated.
	The outer door is open.	"Err38:Door Lock Failure" is displayed in the message display field.	Continuous tone (when the outer door is open.)	ON (when the outer door is open.)	Resolve time is extended.

Table 9 Alarm and Safety functions for STD Gas Calibration

Alarm or safety function	Conditions	Display	Buzzer	Remote alarm	Safety operation
System check error at start/operating of automatic CO ₂ density calibration	The gas pressure of CO ₂ gas line for the standard gas calibration is less than the specified pressure.	"Std Gas Calib Error" and "Err41: CO2 Std Gas Empty " are displayed in the center of the LCD touch panel.	Intermittent tone	ON	The STD Gas calibration is cancelled.

Note: MCO-170AICUVH or when an optional electric lock MCO-170EL is installed to the MCO-170UV/170AIC, an unlock key is provided in order to unlock the outer door during a power interruption or in case the electric lock fails. Always store this key in a safe place. It is recommended that you make a note of the key symbol and number in case the key is lost.

WARNING

Do not use the unlock key to unlock the outer door during H₂O₂ decontamination or during H₂O₂ gas resolve by UV. Doing so may cause harm to health from H₂O₂ gas leakage.

TROUBLESHOOTING

If the incubator does not seem to be working properly, check the following items before calling for service.

Symptom	Items to check and countermeasures
The incubator does not operate at all.	<ul style="list-style-type: none"> • Is the incubator plugged in? • Is there a power outage, or has a circuit breaker interrupted the power? • The removal power supply cord is connected to the port attached on the lower right side of the cabinet.
An alarm is activated.	<p>【When starting operation】</p> <ul style="list-style-type: none"> • Does the chamber temperature match the set value? • Does the CO₂ gas density in the chamber match the set value? <p>(1) Is the secondary pressure for the gas regulator at the specified value of 0.03 MPa(G) (0.3 kgf/cm²(G), 4.3 psi(G))?</p> <p>(2) Is the gas tube properly connected?</p> <p>【During operation】</p> <ul style="list-style-type: none"> • Is the high limit alarm temperature set at least 1 °C higher than the chamber set temperature? • Has the temperature setting been changed? Has the outer door been left open for a long time? Has a low-temperature object been placed in the chamber? If any of these is the case, the alarm will be automatically cleared if you wait. • Has the gas tube come loose, or is there a gas leak? • Has the CO₂ gas density setting been changed? • Is the gas cylinder empty? Check the primary pressure of the gas cylinder once a week. (When the primary pressure is 3.8 MPa(G) (38 kgf/cm²(G), 551 psi(G)) or lower, it is a sign that there is little gas remaining. Replace the cylinder soon.) • Is the incubator operating beside the appliance that generates the electromagnetic wave?
The chamber temperature does not match the set value.	<ul style="list-style-type: none"> • Is the ambient temperature less than 5 °C different from the set value for the chamber temperature? • Is the outer door closed with the inner door left open? • Is the incubator operating beside the appliance that generates the electromagnetic wave?
The chamber humidity does not rise.	<ul style="list-style-type: none"> • Is there enough water in the humidifying pan? (Be sure to use sterile distilled water.)
The CO ₂ gas density does not match the set value.	<ul style="list-style-type: none"> • Is the secondary pressure for the gas regulator at the specified value of 0.03 MPa(G) (0.3 kgf/cm²(G), 4.3 psi(G))? • Is the gas tube blocked? • Is the duct securely attached? Attach the duct properly to the 4 points hooks. (Fig. 1 on page 83) • Is the fan attached properly? Confirm if the fan is pushed all the way to the motor shaft. (Fig. 2 on page 83) • Is the incubator operating beside the appliance that generates the electromagnetic wave?
A large quantity of CO ₂ gas is being consumed.	<ul style="list-style-type: none"> • Are the outer and inner doors being frequently opened and closed? • Check whether gas is leaking from connectors due to deterioration of the gas tube, or whether there may be any pinhole leaks. The gas tube is a replaceable part, and it is recommended that it be replaced once a year. • Is the packing seal for the inner door defective? • Is the access hole open?

TROUBLESHOOTING

Symptom	Items to check and countermeasures
Normal cultures are not possible, and the CO ₂ gas density is suspect.	<ul style="list-style-type: none"> • Is the ambient air environment around the incubator normal? Is there a source of polluted gas in the vicinity?
CO ₂ gas is not being injected.	<ul style="list-style-type: none"> • The CO₂ control method for the incubator is the ON-OFF method. CO₂ gas is intermittently injected as the gas density in the chamber approaches the set value. Injections may be stopped for periods of approximately 15 seconds, but that is not an error. • The gas is not injected until the temperature of the CO₂ sensor becomes stable enough approx. 1 hour, after turning ON the power switch or recovering from power failure.
The CO ₂ gas density is slow to recover.	<ul style="list-style-type: none"> • A HEPA filter is used for the incubator CO₂ gas piping. If gas density is slow to recover when the CO₂ gas pressure is normal, it is possible that the HEPA filter may be clogged. Contact our sales representative or agent. • Is there little gas remaining in the CO₂ gas cylinder? • Is the secondary pressure for the gas regulator at the specified value of 0.03 MPa(G) (0.3 kgf/cm²(G), 4.3 psi(G))? • Is the gas tube blocked? • Is the duct securely attached? Attach the duct properly to the 4 points hooks. (Fig. 1) • Is the fan attached properly? Confirm if the fan is pushed all the way to the motor shaft. (Fig. 2)
UV lamp lights when the outer door is open.	<ul style="list-style-type: none"> • Does something push the door switch?
The outer door does not open.	<p>MCO-170AICUVH, or when the optional MCO-170EL is installed:</p> <ul style="list-style-type: none"> • When the power switch is OFF, the electric lock is locked and the outer door does not open. Either turn ON the power switch or use the accessory unlock key to override the electric lock. • During decontamination the outer door is electrically locked and does not open.

Symptom	Items to check and countermeasures
<p>H₂O₂ decontamination cannot be performed.</p>	<ul style="list-style-type: none"> • If the MCO-170AICUVH is being used, is the optional MCO-HP installed? • If the MCO-170AICUV is being used, are the optional MCO-HP, the optional MCO-170HB and the MCO-170EL installed? • If the MCO-170AIC is being used, are the optional MCO-170UVS, the MCO-HP, the optional MCO-170HB and the MCO-170EL installed? • Is the UV lamp burned out? If the UV lamp is burned out, H₂O₂ decontamination will not be possible. • Is the H₂O₂ generator cable properly connected? • Has the entire bottle of the H₂O₂ reagent been used? • Has the high limit temperature alarm been set to 50 °C or higher?
<p>In H₂O₂ decontamination cycle, "Err34:H2O2 Volume" is activated.</p>	<ul style="list-style-type: none"> • Is the duct securely attached? Attach the duct properly to the 4 points hooks. (Fig. 1) • Is the fan attached properly? Confirm if the fan is pushed all the way to the motor shaft. (Fig. 2) • Is the H₂O₂ generator securely installed? Set the 2 pins of the H₂O₂ generator in the 2 holes at the left bottom of the duct. (Fig. 3) • Is it the end-of-life of the H₂O₂ generator? If the total operating time exceeds 5,000 hours, replace the H₂O₂ generator.

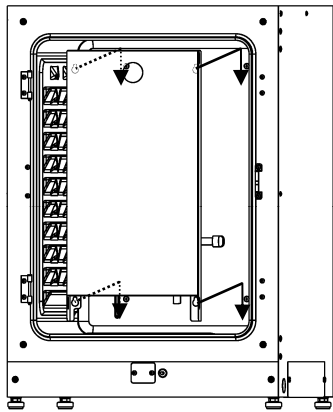
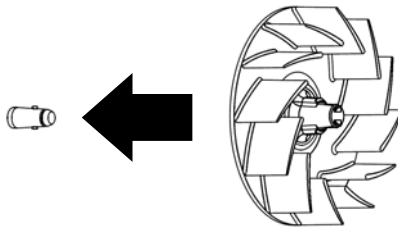

Fig. 1

① Position the center hole of the fan with the projection of the motor shaft. And insert it deeply.



② Lightly turn the fan manually to make sure that it does not touch the rear panel.

③ Lightly pull the fan manually to make sure that it is installed.

Fig. 2

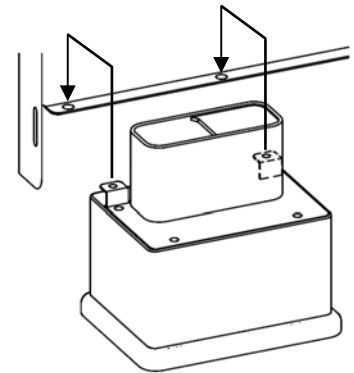

Fig. 3

Note: If the problem still has not been solved after trying the above checks and countermeasures, or for any problems not covered here, contact our sales representative or agent.

Keep an electric product which emits an electromagnetic wave away from this product. A noise from an electromagnetic wave may cause malfunction to this product.

DISPOSAL OF UNIT

When disposing of the CO₂ incubator, contact our sales representative or agent.

 **WARNING**

The CO₂ incubator must be dismantled and disposed of by qualified personnel only. If the CO₂ incubator is left where outsiders enter, it may result unexpected accident (for example, children to become locked inside).

Before disposing the CO₂ incubator with biohazardous danger, decontaminate the CO₂ incubator to the extent possible by the user.

Note:

This symbol mark and recycle system apply only to EU countries. They do not applied to the countries in other areas of the world.



(English)

This Panasonic product is designed and manufactured with high-quality materials and components that can be recycled and reused.

This symbol means that the electrical and electronic equipment, at their end-of-life, should be disposed of separately from household wastes.

Dispose of this product at your local community waste collection/recycling center.

In the European Union there are separate collection systems for used electrical and electronic products.

Please help us to conserve the environment we live in.

(German)

Ihr Panasonic Produkt wurde entworfen und hergestellt mit qualitativ hochwertigen Materialien und Komponenten, die recycelt und wiederverwendet werden können.

Dieses Symbol bedeutet, daß elektrische und elektronische Geräte am Ende ihrer Nutzungsdauer von Hausmüll getrennt entsorgt werden sollen.

Bitte entsorgen Sie dieses Gerät bei Ihrer örtlichen kommunalen Sammelstelle oder im Recycling Centre.

In der Europäischen Union gibt es unterschiedliche Sammelsysteme für Elektrik- und Elektronikgeräte.

Helfen Sie uns bitte, die Umwelt zu erhalten, in der wir leben!

DISPOSAL OF UNIT



(French)

Votre produit Panasonic est conçu et fabriqué avec des matériaux et des composants de qualité supérieure qui peuvent être recyclés et réutilisés.

Ce symbole signifie que les équipements électriques et électroniques en fin de vie doivent être éliminés séparément des ordures ménagères.

Nous vous prions donc de confier cet équipement à votre centre local de collecte/recyclage.

Dans l'Union Européenne, il existe des systèmes sélectifs de collecte pour les produits électriques et électroniques usagés.

Aidez-nous à conserver l'environnement dans lequel nous vivons !

Les machines ou appareils électriques et électroniques contiennent fréquemment des matières qui, si elles sont traitées ou éliminées de manière inappropriée, peuvent s'avérer potentiellement dangereuses pour la santé humaine et pour l'environnement.

Cependant, ces matières sont nécessaires au bon fonctionnement de votre appareil ou de votre machine. Pour cette raison, il vous est demandé de ne pas vous débarrasser de votre appareil ou machine usagé avec vos ordures ménagères.

(Spanish)

Los productos Panasonic están diseñados y fabricados con materiales y componentes de alta calidad, que pueden ser reciclados y reutilizados.

Este símbolo significa que el equipo eléctrico y electrónico, al final de su ciclo de vida, no se debe desechar con el resto de residuos domésticos.

Por favor, deposite su viejo equipo en el punto de recogida de residuos o contacte con su administración local.

En la Unión Europea existen sistemas de recogida específicos para residuos de aparatos eléctricos y electrónicos.

Por favor, ayúdenos a conservar el medio ambiente!



(Portuguese)

O seu produto Panasonic foi concebido e produzido com materiais e componentes de alta qualidade que podem ser reciclados e reutilizados.

Este símbolo significa que o equipamento eléctrico e electrónico no final da sua vida útil deverá ser descartado separadamente do seu lixo doméstico.

Por favor, entregue este equipamento no seu ponto local de recolha/reciclagem.

Na União Europeia existem sistemas de recolha separados para produtos eléctricos e electrónicos usados.

Por favor, ajude-nos a conservar o ambiente em que vivemos!

(Italian)

Il vostro prodotto Panasonic è stato costruito da materiali e componenti di alta qualità, che sono riutilizzabili o riciclabili.

Prodotti elettrici ed elettronici portando questo simbolo alla fine dell'uso devono essere smaltiti separatamente dai rifiuti casalinghi.

Vi preghiamo di smaltire questo apparecchio al deposito comunale.

Nell'Unione Europea esistono sistemi di raccolta differenziata per prodotti elettrici ed elettronici.

Aiutateci a conservare l'ambiente in cui viviamo!

DISPOSAL OF UNIT



(Dutch)

Panasonic producten zijn ontwikkeld en gefabriceerd uit eerste kwaliteit materialen, de onderdelen kunnen worden gerecycled en weer worden gebruikt.

Het symbool betekent dat de elektrische en elektronische onderdelen wanneer deze vernietigd gaan worden, dit separaat gebeurt van het normale huisafval.

Zorg ervoor dat het verwijderen van de apparatuur bij de lokaal erkende instanties gaat gebeuren. In de Europese Unie wordt de gebruikte elektrische en elektronische apparatuur bij de daarvoor wettelijke instanties aangeboden.

Alstublieft help allen mee om het milieu te beschermen.

(Swedish)

Din Panasonic produkt är designad och tillverkad av material och komponenter med hög kvalitet som kan återvinnas och återanvändas.

Denna symbol betyder att elektriska och elektroniska produkter, efter slutanvändande, skall sorteras och lämnas separat från Ditt hushållsavfall.

Vänligen, lämna denna produkt hos Din lokala mottagningstation för avfall/återvinningsstation.

Inom den Europeiska Unionen finns det separata återvinningsystem för begagnade elektriska och elektroniska produkter.

Vänligen, hjälp oss att bevara miljön vi lever i!

SPECIFICATIONS

Product name	CO ₂ incubator MCO-170AIC	CO ₂ incubator MCO-170AICUV	CO ₂ incubator MCO-170AICUVH
Medical purpose	Culture of cell tissues, organs, embryos.		
External dimensions	W620 mm x D730 mm x H905 mm (W24.4 inch x D28.7 inch x H35.6 inch)		
Internal dimensions	W490 mm x D523 mm x H665 mm (W19.3 inch x D20.6 inch x H26.2 inch)		
Interior volume	165 L (5.83 cu.ft.)		
Exterior	Painted steel (Rear cover has no paint)		
Interior	Stainless steel containing copper		
Outer door	Painted steel		
Inner door	Tempered glass		
Trays	4 trays made of stainless steel containing copper W470 mm x D450 mm x H12 mm (W18.5 inch x D17.7 inch x H0.47 inch) Maximum load: 7 kg/tray		
Access port	Inner diameter: 30 mm (1.18 inch), On the back side		
Insulation	Extruded polystyrene		
Heating system	DHA system (heater jacket + air jacket system)		
Heater	295 W		
Humidifying system	Natural evaporation with humidifying pan		
Temperature controller	PID control system		
Temperature display	Digital display		
CO ₂ controller	PID control system		
CO ₂ density display	Digital display		
Air circulation	Fan assisted		
Air filter	0.3 μm, Efficiency: 99.97 % or higher		
UV lamp	-----	4 W x 1 (ozone-free emission)	
Alarms	Automatic set temperature alarm, Automatic set CO ₂ density alarm, High limit temperature alarm, CO ₂ gas, various sensor/heater alarms		
Remote alarm contacts	Allowable contact capacity: DC 30 V, 2 A		
CO ₂ inlet connection	4 mm to 6 mm (0.157 inch to 0.236 inch) diameter tube can be connected		
CO ₂ inlet pressure	0.03 MPa(G) (0.3 kgf/cm ² (G), 4.3 psi(G))		
Weight	80 kg		
Accessories	-----	2 unlock key	
	4 trays, 1 gas tube, 1 humidifying pan, 2 tube bands 1 removal power supply cord for UK 1 removal power supply cord for EU countries other than UK		

SPECIFICATIONS

Product name	CO ₂ incubator MCO-170AIC	CO ₂ incubator MCO-170AICUV	CO ₂ incubator MCO-170AICUVH
Optional accessories (Refer to table 10)	UV system set (MCO-170UVS)	standard equipment	
	H ₂ O ₂ decon board (MCO-170HB) Electric lock (MCO-170EL)		standard equipment
	H ₂ O ₂ generator (MCO-HP)		
Optional accessories (Refer to table 11)	Double stacking bracket (MCO-170PS) Stacking plate (MCO-170SB)		
Optional accessories	H ₂ O ₂ reagent (MCO-H2O2-PE) Gas regulator (MCO-100L-PW) Gas auto changer (MCO-21GC-PW) STD gas auto calibration kit (MCO-SG-PW) Tray (MCO-170ST: same as that of standard accessory) Half tray (MCO-25ST) Roller base (MCO-170RB)		
Optional Software product	Data acquisition system (MTR-5000) Interface board (MTR-L03); For LAN Interface board (MTR-480); For RS-232C/RS-485		
Optional product for using in the chamber	Shaker for CO ₂ incubator (MIR-S100C)		

Note: Refer to the updated catalog when ordering an optional component.

Designs and specifications are subject to change without notice.

Table 10 Optional accessories for each function

	MCO-170AIC	MCO-170AICUV	MCO-170AICUVH
To disinfect by UV	UV system set (MCO-170UVS)	standard equipment	
To decontaminate by H ₂ O ₂ .	UV system set (MCO-170UVS) H ₂ O ₂ generator (MCO-HP) H ₂ O ₂ decon board (MCO-170HB) Electric lock (MCO-170EL)	H ₂ O ₂ generator (MCO-HP) H ₂ O ₂ decon board (MCO-170HB) Electric lock (MCO-170EL)	H ₂ O ₂ generator (MCO-HP)
To lock the outer door	Electric lock (MCO-170EL)		standard equipment

Table 11 Required bracket/plate for each incubator combination of double stacking

Upper product	MCO-170AIC MCO-170AICUV MCO-170AICUVH				
Lower product	MCO-170AIC MCO-170AICUV MCO-170AICUVH	MCO-19AIC MCO-19AICUV MCO-19AICUVH	MCO-19M MCO-19MUV MCO-19MUVH	MCO-18AC	MCO-20AIC
Bracket Plate	Double stacking bracket MCO-170PS	Stacking plate MCO-170SB			

PERFORMANCE

Product name	CO ₂ Incubator MCO-170AICUVH MCO-170AICUV MCO-170AIC
Model No.	MCO-170AICUVH-PE MCO-170AICUV-PE MCO-170AIC-PE
Temperature control range	Ambient temperature+5 °C to 50 °C* (ambient temperature: 5 °C to 35 °C)
Temperature distribution	±0.25 °C (ambient temperature: 23 °C, setting: 37 °C, CO ₂ : 5 %, no load)
Temperature variation	±0.1 °C (ambient temperature: 23 °C, setting: 37 °C, CO ₂ : 5 %, no load)
CO ₂ control range	0 % to 20 %
CO ₂ variation	±0.15 % (ambient temperature: 23 °C, setting: 37 °C, CO ₂ : 5 %, no load)
Chamber humidity	95 %R.H.±5 %R.H.
Applicable environment condition	Temperature: 5 °C to 35 °C, Humidity: 80 %R.H. max. (The designed performance may not be obtained If the ambient temperature is equal or less than 15 °C)
Noise level	29 dB (A scale)
Power consumption	Max. 379 W
Heat emission	Max. 1,070 kJ/h
Rated voltage, frequency	AC 220 V-240 V, 50 Hz
Amperage	Max. 1.8 A

*When ambient temperature is 25 °C, temperature control range: 30 °C~50 °C. Regardless of ambient temperature, the maximum of temperature control range is always 50 °C.

Note: The unit with CE mark complies with EC directives.
Based on our measuring method.

⚠ CAUTION

**Please fill in this form before servicing.
Hand over this form to the service engineer to keep for his and your safety.**

Safety check sheet

1. Unit contents :

- Risk of infection: Yes No
Risk of toxicity: Yes No
Risk from radioactive sources: Yes No

(List all potentially hazardous materials that have been stored in this unit.)

Notes :

2. Contamination of the unit

Unit interior

- No contamination Yes No
Decontaminated Yes No
Contaminated Yes No

Others:

3. Instructions for safe repair/maintenance of the unit

- a) The unit is safe to work on Yes No
b) There is some danger (see below) Yes No

Procedure to be adhered to in order to reduce safety risk indicated in b) below.

Date :

Signature :

Address, Division :

Telephone :

Product name :

CO₂ incubator

Model No.

MCO-

Serial number :

Date of Installation :

Please decontaminate the unit yourself before calling the service engineer.

Original Operating Instructions

< EU countries only >



Panasonic Marketing Europe GmbH

Panasonic Testing Centre

Winsbergring 15, 22525 Hamburg, Germany

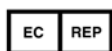

Panasonic Healthcare Co., Ltd.

1-1-1 Sakata, Oizumi-Machi, Ora-Gun, Gunma 370-0596 Japan

© Panasonic Healthcare Co., Ltd. 2014

Printed in Japan
7FB6P15171100
S0514-0
2014.05.27